

Zelio Control Monitoring & Control Relays

Catalog

December 2016



Quick access to Product information

Select your Catalogue, your Training

Digi-Cat

The complete digital catalogue for industrial automation



Makes your choice easy every day, everywhere!



With just 3 clicks, you can reach the 7,000 pages of the Automation & Industrial Control catalogue, in both English and French.

- Digi-Cat is available on a USB key (for PC). To get your Digi-Cat, please contact your local center
- Download Digi-Cat from this address:

<http://digi-cat.schneider-electric.com/download.html>

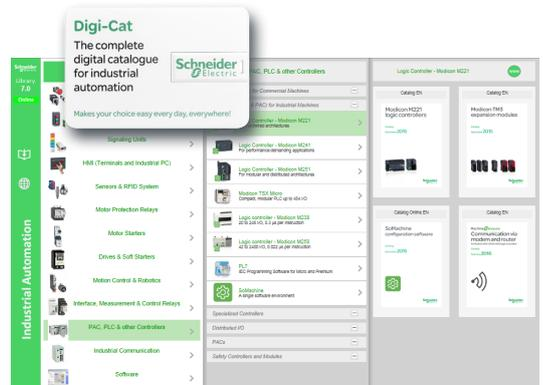

Find your training

- Find the right training for your needs
- Locate the training center with the selector tool, using this address:

<http://www.schneider-electric.com/b2b/en/services/training/technical-training.jsp>

then click on

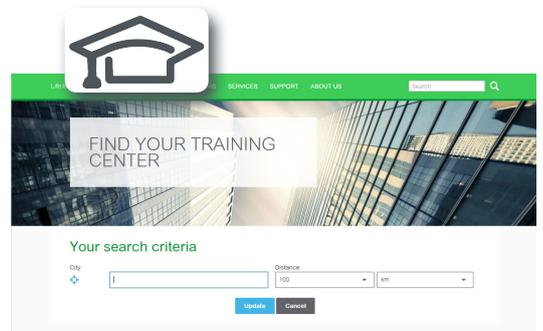

Life Is On



General contents

Zelio Control – Monitoring & Control Relays

■ General Presentation	page 2
<i>Selection guide</i>	<i>page 4</i>
■ RM17TG 3-phase supply control relays	page 12
■ RM22TA, RM22TU, RM22TR, and RM22TG Multifunction 3-phase supply control relays	page 14
■ RM17T●00 Multifunction 3-phase supply control relays	page 18
■ RM35TF Multifunction 3-phase supply control relays	page 22
■ RM17UB3 and RM35UB3 3-phase voltage control relays	page 24
■ RM35TM 3-phase supply and motor temperature control relays	page 28
■ RM17UAS and RM17UBE 1-phase voltage control relays	page 32
■ RM35UA Multifunction 1-phase voltage control relays	page 36
■ RM22UA and RM22UB 1-phase voltage control relays	page 38
■ RM17JC 1-phase current control relays with integrated current transformer	page 42
■ RM22JA and RM35JA 1-phase current control relays	page 44
■ RM35JA 1-phase current control relays	page 48
■ RM22LA and RM22LG Liquid level control relays	page 50
■ RM35L Level control relays	page 54
■ RM35BA 3-phase and 1-phase pump control relays	page 58
■ RM35HZ Frequency control relay	page 60
■ RM35S Speed control relay	page 62
■ RM35AT● Temperature control relays for elevator machine rooms and 3-phase supplies	page 66
■ Electrode holders and probes	page 68
■ Product reference index	page 70

Zelio Control – Monitoring & Control Relays

Zelio Control relays monitor and detect abnormal operating conditions concerning phase, current, voltage, frequency, speed, or temperature. The relays inform users of abnormal conditions, and allow them to initiate the necessary corrective actions before serious and costly breakdowns can occur. By monitoring energy network statuses, they enable both electrical and mechanical load control.



RM17T, RM35L, RM17J Zelio Control Relays

They are suitable for a wide range of applications:

- Hoisting: construction cranes, harbor cranes
- Packaging: motor voltage, current overload
- Lifts: construction lifts, passenger lifts, escalators
- Textile: motor voltage, current overload
- Water: liquid level on water tank at water and waste water recycling plant

Depending on the product model, control relays are categorized into 8 product families:

- 3-phase control
- Current control
- Voltage control
- Frequency control
- Speed control
- Lift temperature control
- Level control
- Pump control

Zelio Control relay functions

Monitoring

Control relays monitor physical and electrical values. They measure variable signals such as phase (presence, sequence and symmetry), voltage, current, and frequency. They also control liquid levels and process operating rates.

Informing

Control device outputs provide users with electrical information. In addition, setting faults are signaled by simultaneous flashing of all LEDs.

Protecting

Integrated in the control circuits of automated systems, they enable automatic shutdown management and provide fault information, thus protecting the equipment.

Managing

When the power is switched on, the control relays are inhibited to enable correct measurement circuit setting. The outputs operate with positive logic, the contact or contacts being closed under normal conditions and opening as soon as a fault or power supply loss is detected.

Commissioning

When the diagnostic button is used, the downstream circuit can be closed immediately without sending a fault input signal to the relays. This shortens the testing time during commissioning and troubleshooting.

Zelio Control relays with unique design and features

- > Compact modular sizes: 17.5 mm/0.69 in., 22.5 mm/0.88 in., 35 mm/1.38 in.
- > Adapted for industrial and building control panels
- > True RMS measurement that minimizes the possibility of unexpected trips from highly polluted networks
- > Diagnostic button to check the downstream circuit immediately and reduce commissioning and troubleshooting time (1)
- > IP50 lead-sealable settings protection cover helps prevent dust and unintended human intervention
- > Status indication by LEDs, additional dial pointer LED for easy setup in dark conditions (1), and power “On” status indication when relay is ready to perform



- > Optimization of power supplies
- > Worldwide certification:



(1) Available in RM35JA32MR, RM35JA32MT, and all RM22 references.

Zelio Control - Monitoring & Control Relays

Application	3-phase control			
Functions	- Phase sequence - Phase loss	- Phase sequence - Phase loss	- Phase sequence - Phase loss	- Phase sequence - Phase loss - Overvoltage and undervoltage
Values controlled	208...480 V ~ 208...440 V ~	183...528 V ~	208...480 V ~	200...240 V ~ 380...480 V ~
Output contact rating	1 or 2 CO 5 A	2 CO 8 A	1 CO 5 A	2 CO 8 A
Supply voltage	Self-powered			
Time delay	-			0.1...30 s
Size (mm/in.)	17.5/0.69	22.5/0.885	17.5/0.69	22.5/0.885
Modular relay type	RM17TG0	RM22TG20	RM17TT00	RM22TR31 RM22TR33
Pages	12	14	18	14

3-phase control						
- Phase sequence - Phase loss - Undervoltage	- Phase sequence - Phase loss - Asymmetry	- Phase sequence - Phase loss - Asymmetry	- Phase sequence - Phase loss - Asymmetry - Overvoltage and undervoltage	- Overvoltage and undervoltage between phases - Overvoltage and undervoltage between phases and neutral - Absence of neutral/phase	- Phase sequence - Phase loss	- Phase sequence - Phase loss - Motor temperature
208...480 V ~	200...240 V ~ 380...480 V ~	208...480 V ~	200...240 V ~ 380...480 V ~	208...480 V ~ 220...480 V ~	220...480 V ~ 208...480 V ~ 120...277 V ~	208...480 V ~ Motor temperature: PTC probe resistance 15 Ω to 3100 Ω
1 CO 5 A	2 CO 8 A	1 CO 5 A	2 CO 8 A	1 or 2 CO 5 A	1 CO or 2 CO 5 A	2 NO 5 A
Self-powered						
0.1...10 s	-	0.1...10 s	0.1...30 s	0.1...10 s	0.3...30 s	-
17.5/0.69	22.5/0.885	17.5/0.69	22.5/0.885	17.5/0.69 or 35/1.377	17.5/0.69 or 35/1.377	35/1.377
RM17TU00	RM22TU21 RM22TU23	RM17TA00	RM22TA31 RM22TA33	RM17TE00 RM35TF30	RM17UB310 RM35UB3000	RM35TM50MW
18	14	18	14	18, 22	24	28

Zelio Control - Monitoring & Control Relays

Application	1-phase voltage control	
Functions	- Overvoltage or undervoltage with/without memory	
		
Values controlled	9...15 V $\overline{\sim}$ 20...80 V $\overline{\sim}$ 65...260 V $\overline{\sim}$	0.05...5 V $\overline{\sim}$ 1...100 V $\overline{\sim}$ 15...600 V $\overline{\sim}$
Output contact rating	1 CO 5 A	2 CO 5 A
Supply voltage	Self-powered	24...240 V $\overline{\sim}$
Time delay	0.1...10 s	0.3...30 s
Size (mm/in.)	17.5/0.69	35/1.377
Modular relay type	RM17UAS1	RM35UA1 MW
Pages	32	36

1-phase voltage control			
- Overvoltage (without memory)	- Overvoltage (with/without memory) - Undervoltage (with/without memory) - Overvoltage or undervoltage in window mode (with/without memory)	- Overvoltage and undervoltage in window mode	
			
0.05...5 V $\overline{\sim}$ 1...100 V $\overline{\sim}$ 15...500 V $\overline{\sim}$	0.05...5 V $\overline{\sim}$ 1...100 V $\overline{\sim}$ 15...500 V $\overline{\sim}$	20...80 V $\overline{\sim}$ 65...260 V $\overline{\sim}$	80...300 V $\overline{\sim}$
2 CO 8 A	2 CO 8 A	1 CO 5 A	2 CO 8 A
24...240 V $\overline{\sim}$	24...240 V $\overline{\sim}$ 380...415 V $\overline{\sim}$	Self-powered	110...240 V $\overline{\sim}$
-	0.1...30 s	0.1...10 s	0.1...30 s
22.5/0.885	22.5/0.885	17.5/0.69	22.5/0.885
RM22UA21MR RM22UA22MR RM22UA23MR	RM22UA31MR RM22UA32MR RM22UA33MR RM22UA33MT	RM17UBE1	RM22UB34
38	38	32	38

Zelio Control - Monitoring & Control Relays

Application		
1-phase current control		
Functions		
	Integrated current transformer	No integrated current transformer
	- Overcurrent without memory	
		
Values controlled	2...20 A	4...100 mA
Output contact rating	1 CO 5 A	2 CO 8 A
Supply voltage	24...240 V \sphericalangle	24...240 V \sphericalangle
Time delay	-	
Size (mm/in.)	17.5/0.69	22.5/0.885
Modular relay type	RM17JC00MW	RM22JA21MR
Pages	42	44

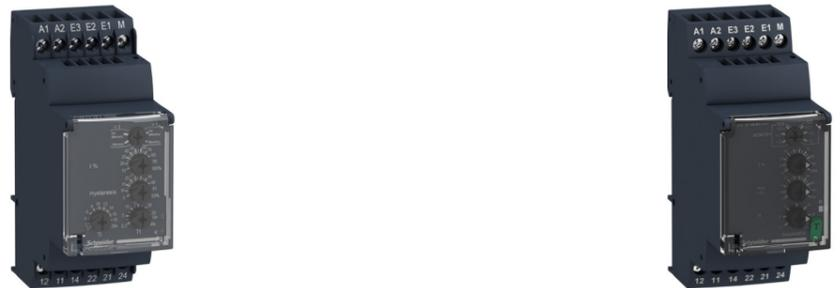
Application		
1-phase current control		
No integrated current transformer		
	- Overcurrent with/without memory - Undercurrent with/without memory	- Overcurrent with/without memory - Undercurrent with/without memory - Overcurrent and undercurrent with/without memory and window mode
		
Values controlled	2...500 mA 0.15...15 A	4...100 mA 150...15,000 mA
Output contact rating	2 CO 5 A	2 CO 8 A
Supply voltage	24...240 V \sphericalangle	24...240 V \sphericalangle 380...415 V \sphericalangle
Time delay	Inhibition time delay upon startup 1...20 s Time delay 0.3...30 s	0.1...30 s
Size (mm/in.)	35/1.377	22.5/0.885, 35/1.377
Modular relay type	RM35JA31MW RM35JA32MW	RM22JA31MR RM35JA32MR RM35JA32MT
Pages	48	44

Zelio Control - Monitoring & Control Relays

Application	Level control			
Functions	By resistive probes - Level 1/Level 2 - Fill operation - Empty operation - Standard sensitivity	By resistive probes - Level 1/Level 2 - Fill operation - Empty operation - Low sensitivity - Standard sensitivity - High sensitivity	By resistive probes - Level 1/Level 2 - Fill operation - Empty operation - Low sensitivity - Standard sensitivity - High sensitivity	By discrete sensor - Empty or fill - Input for discrete sensor AON: Contact/ PNP/NPN
Values controlled	5...100 kΩ	0.25...5 kΩ 5...100 kΩ 0.05...1 MΩ	0.25...5 kΩ 5...100 kΩ 0.05...1 MΩ	–
Output control rating	1 CO 8 A	2 CO 5 A	2 CO 8 A	1 CO 5 A
Supply voltage	24...240 V ~ 380...415 V ~	24...240 V ~	24...240 V ~ 380...415 V ~	24...240 V ~
Time delay	–	0.1...5 s	0.1...30 s	0.1...5 s
Size (mm/in.)	22.5/0.885	35/1.377	22.5/0.885	35/1.377
Modular relay type	RM22LG11MR RM22LG11MT	RM35LM33MW	RM22LA32MR RM22LA32MT	RM35LV14MW
Pages	50	54	50	54

Pump control	Frequency control	Speed control	Temperature control for elevator machine rooms and 3-phase supplies	
3-phase and 1-phase - Overcurrent and undercurrent - Phase sequence on 3-phase supply - Phase loss on 3-phase supply	- Over-frequency and under-frequency (with/without memory)	- Over or under operating rate/speed (with/without memory)	- Elevator Machine room temperature - Over temperature and under temperature	- Elevator Machine room temperature - Over temperature and under temperature - Phase loss and phase sequence
Current: 1...10 A 3-phase 208...480 V ~ 1-phase 230 V ~	Mains supply: 50 or 60 Hz High threshold: - 2...+ 10 Hz Low threshold: - 10...+ 2 Hz	Time controlled between pulses: 0.05...0.5 s, 0.1...1 s, 0.5...5 s, 1...10 s 0.1...1 min, 0.5...5 min, 1...10 min	Temperature Low threshold: - 1...11 °C High threshold: 34...46 °C	Temperature Low threshold: - 1...11 °C High threshold: 34...46 °C 3-phase supplies 208...480 V ~
1 CO 5 A	2 CO 5 A	1 CO 5 A	1 CO 5 A or 2 NO 5 A	2 NO 5 A
208...480 V ~, 3-phase 230 V ~, 1-phase	120...277 V ~	24...240 V ~	24...240 V ~	24...240 V ~
Inhibition time delay upon startup 1...60 s Time delay 0.1...10 s	0.1...10 s	Inhibition time delay upon startup 0.6...60 s	1...10 s	
35/1.377	35/1.377	35/1.377	35/1.377	35/1.377
RM35BA10	RM35HZ21FM	RM35S0MW	RM35ATL0MW RM35ATR5MW	RM35ATW5MW
58	60	62	66	66

Zelio Control - Monitoring & Control Relays

3-phase supply control relays
RM17TG



RM17TG00

Presentation

RM17TG00 measurement and control relays for 3-phase supplies monitor the correct sequencing of phases L1, L2, and L3 and the total loss of one or more of these phases.

Functions	RM17TG
Sequence of phases L1, L2, and L3	
Phase loss	

- Function performed
- Function not performed

Depending on the model, RM17TG control relays:

- Accept different nominal 3-phase voltage values
 - 208...480 V ~ for RM17TG00
 - 208...440 V ~ for RM17TG20
- Monitor their own power supply measured as a true rms value
- Are designed for clip-on mounting on a 35 mm rail

The control status is indicated by an LED.

Applications

- Control for connection of moving equipment (site equipment, agricultural equipment, refrigerated trucks)
- Control against reverse motor operation (lifting, handling, elevators, escalators, etc.)
- Control of sensitive 3-phase supplies
- Emergency power supply switching in abnormal conditions

Description

RM17TG00 , RM17TG20

- 1 Spring for clip-on mounting on 35 mm/1.38 in. rail

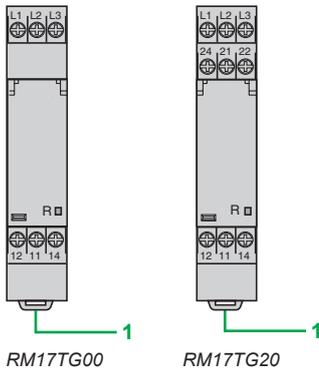

R Yellow LED: indicates relay output status

Zelio Control - Monitoring & Control Relays

3-phase supply control relays
RM17TG

Operating principle

3-phase supply control relays monitor:

- Correct sequencing of phases L1, L2, and L3
- Fault signaling by LEDs
- Total loss of one or more of the phases

Function Diagram

-  Output 11-14, 21-24 open
-  Output 11-14, 21-24 closed

RM17TG●0

Phase control

- Sequence of phases L1, L2, and L3
- Phase loss

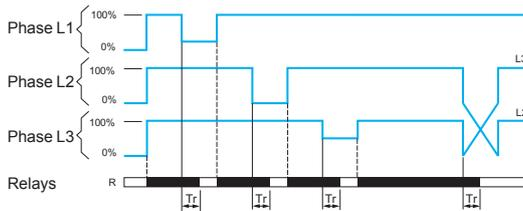

The relays monitor:

- That the phase sequence and voltages are correct (> 183 V), the output relay(s) is/are closed and the yellow LED is on.
- If a sequencing fault or total loss of one or more phases is detected (detected as soon as one of the voltages drops below 100 V), the relay opens instantly and the LED goes off.
- On energization of the device with a detected measured fault, the relay stays open.

Note: *Tr*: response time on detection of a fault

References



RM17TG00



RM17TG20

Function	Rated 3-phase supply voltage	Output	Reference	Weight
	V			kg/lb
■ Phase sequence ■ Phase loss	208...480 ~	1 CO 5 A	RM17TG00	0.080/ 0.176
	208...440 ~	2 CO 5 A	RM17TG20	0.085/ 0.187

Zelio Control - Monitoring & Control Relays

Multifunction 3-phase control relays
RM22TA, RM22TU, RM22TR, and RM22TG



RM22T●●●

Presentation

RM22 multifunction Zelio control relays monitor the following functions on 3-phase supplies:

Functions	RM22TA	RM22TU	RM22TR	RM22TG
Sequence of phases L1, L2, and L3				
Phase loss				
Asymmetry				
Undervoltage				
Overtoltage and undervoltage				

■ Function performed
□ Function not performed

Depending on the model, RM22●●● control relays:

- Accept different nominal 3-phase voltages: up to 480 V~
- Monitor their own power supply measured as a true rms value
- Are designed for clip-on mounting on a 15 mm rail

They feature a:

- Sealable cover to help protect the settings
- Diagnostic button for load circuit testing
- Relay output status LED
- Fault detection indication LED
- Dial pointer LED indicator for relay power ON status
- Relay output On-delay or Off-delay

Applications

- Control for connection of moving equipment (site equipment, agricultural equipment, refrigerated trucks)
- Control against reverse motor operation (lifting, handling, elevators, escalators, etc.)
- Control of sensitive 3-phase supplies
- Emergency power supply switching in abnormal conditions

Description

RM22TA, RM22TU, RM22TR, RM22TG

- 1a Voltage range selector switch
- 1b Voltage range/On-Off delay selector
- 2 Time delay adjustment potentiometer Tt
- 3a Asymmetry threshold setting potentiometer Asym
- 3b Undervoltage setting potentiometer <U
- 3c Overtoltage setting potentiometer >U
- 4 Diagnostic button

Operating principle

Multifunction 3-phase supply control relays monitor:

- Product being powered by L1 and L3
- Correct sequencing of phases L1, L2, and L3
- LED indication for relay output status and fault detection (except phase disconnection)
- Phase loss, including in the case of voltage regeneration
- Undervoltage from - 2... - 20% of the supply voltage Un
- Overtoltage from 2...20% of the supply voltage Un
- Asymmetry from 5...15% of the supply voltage Un

Function Diagram

- Output 11-14, 21-24 open
- Output 11-14, 21-24 closed

Voltage switch operation:

- Set the switch to 3-phase supply voltage Un.
- The position of this switch is taken into account on energization of the device.
- If the switch position is changed while the device is operating, all the LEDs flash but the product continues to operate normally with the voltage selected at the time of energization preceding the change of position.
- If the switch is returned to the original position selected prior to the last energization, the LEDs return to their normal state.

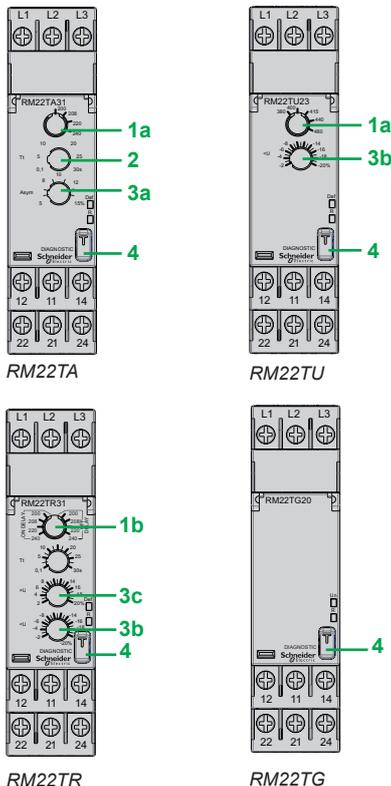

Un Green LED: indicates that supply to the product is on
R Yellow LED: indicates relay output status
DEF Yellow LED: indicates fault detection

Zelio Control - Monitoring & Control Relays

Multifunction 3-phase control relays
RM22TA, RM22TU, RM22TR, and RM22TG

Operating principle (continued)

RM22TA

Phase + Asymmetry

- Sequence of phases L1, L2, and L3
- Phase loss
- Asymmetry **Asy**

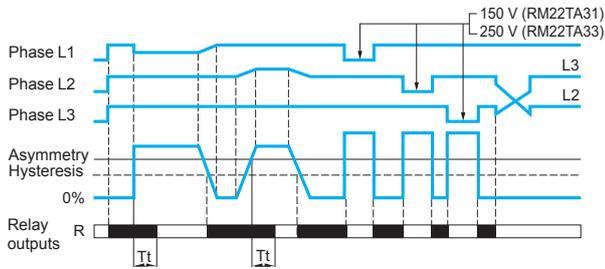

The relay monitors its own supply voltage U_n :

- correct sequence of three phases
- phase loss of at least one of the three phases (U measured < 150 V (RM22TA31) and < 250 V (RM22TA33))
- asymmetry adjustable from 5...15% of U_n
- If a sequencing or phase loss fault is detected, the relay opens instantly.
- If an asymmetry fault is detected, the relay opens at the end of the time delay set by the user.
- On energization of the device with a detected measured fault, the relay stays open.

Note: T_t : time delay after crossing of the threshold (adjustable on the front panel)

RM22TU

Phase + Undervoltage

- Sequence of phases L1, L2, and L3
- Phase loss

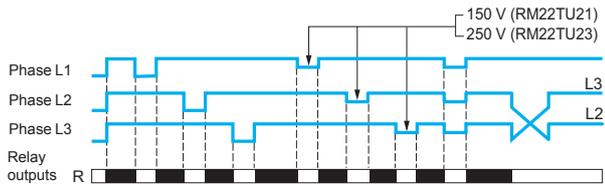

The relay monitors its own supply voltage U_n :

- correct sequence of the three phases
- phase loss of at least one of the three phases (U measured < 150 V (RM22TU21) and < 250 V (RM22TU23))
- undervoltage adjustable from -2...-20% of U_n
- If a sequencing or phase loss fault is detected, the relay opens instantly.
- If a voltage fault is detected, the relay opens instantly.
- On energization of the device with a detected measured fault, the relay stays open.

- Undervoltage control $<U$

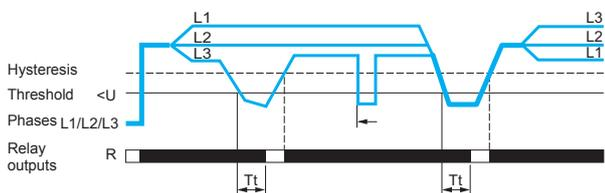

Note: T_t : time delay after crossing of the threshold

Zelio Control - Monitoring & Control Relays

Multifunction 3-phase control relays
RM22TA, RM22TU, RM22TR, and RM22TG

Operating principle (continued)

RM22TR

Phase + Undervoltage/overvoltage

- Sequence of phases L1, L2, and L3
- Phase loss

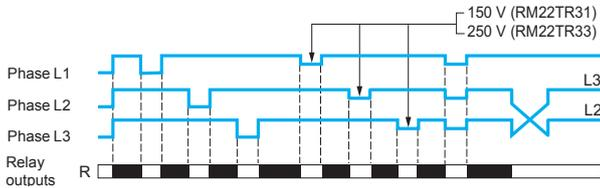

The relay monitors its own supply voltage U_n :

- phase loss (U measured < 150 V (RM22TR31) and < 250 V (RM22TR33))
- undervoltage and overvoltage

- An adjustable time delay on threshold crossing provides immunity to transients, and helps prevent spurious triggering of the output relay.
- If a voltage fault is detected, the relay opens at the end of the time delay set as On-delay or Off-delay by the user.
- On energization of the device with a detected measured fault, the relay stays open.
- In the event of phase loss, the relay opens instantly.

- Overvoltage and undervoltage (Off-delay)

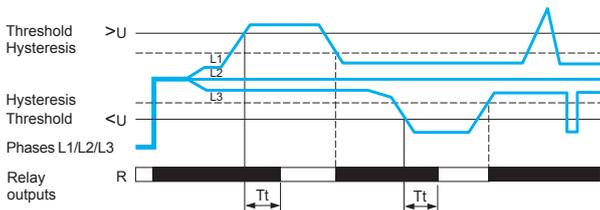

Note: T_t : time delay after crossing of the threshold (adjustable on the front panel)

RM22TG

Phase control

- Sequence of phases L1, L2, and L3
- Phase loss

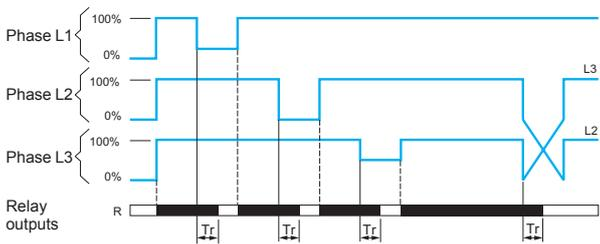

The RM22TG relay monitors:

- correct sequencing of the three phases
- total loss of one or more of the three phases
- When the phase sequence and voltages are correct (> 183 V \sim), the output relays are closed and the R LED is on.
- When there is a sequencing fault or total loss of one or more phases (detected as soon as one of the voltages drops below 100 V) the relay opens instantly and the R LED goes off.
- On energization of the device with a detected measured fault, the relay stays open.

Note: T_r : response time on appearance of a fault

Zelio Control - Monitoring & Control Relays

Multifunction 3-phase control relays
RM22TA, RM22TU, RM22TR, and RM22TG



RM22TA31



RM22TR31



RM22TG20



RM22TU21

References					
Function	Measurement range	Time delay	Output	Reference	Weight
					kg/lb
<ul style="list-style-type: none"> ■ Phase sequence ■ Phase loss ■ Asymmetry 	200...240 ~	Off delay (0.1...30 s)	2 CO 8 A	RM22TA31	0.090/ 0.198
	380...480 ~	Off delay (0.1...30 s)	2 CO 8 A	RM22TA33	0.090/ 0.198
<ul style="list-style-type: none"> ■ Phase sequence ■ Phase loss ■ Undervoltage and overvoltage 	200...240 ~	On/Off delay (0.1...30 s)	2 CO 8 A	RM22TR31	0.090/ 0.198
	380...480 ~	On/Off delay (0.1...30 s)	2 CO 8 A	RM22TR33	0.090/ 0.198
<ul style="list-style-type: none"> ■ Phase sequence ■ Phase loss ■ Undervoltage 	200...240 ~	No	2 CO 8 A	RM22TU21	0.090/ 0.198
	380...480 ~	No	2 CO 8 A	RM22TU23	0.090/ 0.198
<ul style="list-style-type: none"> ■ Phase sequence ■ Phase loss 	183...528 ~	No	2 CO 8 A	RM22TG20	0.090/ 0.198

Zelio Control - Monitoring & Control Relays

Multifunction 3-phase supply control relays
RM17TT, RM17TA, RM17TU, and RM17TE



RM17T•00

Presentation

RM17TT, RM17TA, RM17TU and RM17TE multifunction control relays monitor the following on 3-phase supplies:

Functions	RM17TT	RM17TA	RM17TU	RM17TE
Sequence of phases L1, L2, and L3				
Phase loss	(1)			
Asymmetry				
Undervoltage				
Overtoltage and undervoltage				

■ Function performed
■ Function not performed

Depending on the model, RM17T•00 control relays:

- Accept different nominal 3-phase voltages: 208...480 V ~
- Monitor their own power supply measured as a true rms value
- Are designed for clip-on mounting on a 35 mm rail

They feature:

- A sealable cover to help protect the settings
- A control status indicator LED

Applications

- Control for connection of moving equipment (site equipment, agricultural equipment, refrigerated trucks)
- Control against reverse motor operation (lifting, handling, elevators, escalators, etc.)
- Control of sensitive 3-phase supplies
- Emergency power supply switching in abnormal conditions

Description

RM17TT00, RM17TA00, RM17TU00, RM17TE00

- 1 Voltage range selector switch (208, 220, 380, 400, 415, 440, and 480 V ~)
- 2 Time delay adjustment potentiometer Tt
- 3a Asymmetry threshold setting potentiometer **Asy**
- 3b Undervoltage setting potentiometer **<U**
- 3c Undervoltage/overtoltage setting potentiometer **ΔU**
- 4 Asymmetry threshold setting potentiometer **Asy**
- 5 Spring for clip-on mounting on 35 mm / 1.38 in. rail

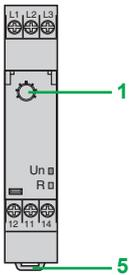

RM17TT00

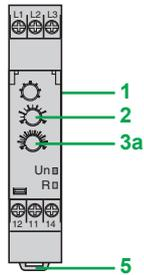

RM17TA00

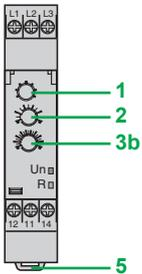

RM17TU00

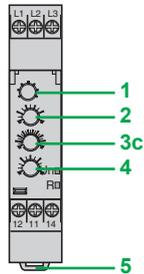

RM17TE00

Un Green LED: indicates that supply to the product is on
R Yellow LED: indicates relay output status

(1) Phase loss with regeneration.

Zelio Control - Monitoring & Control Relays

Multifunction 3-phase supply control relays
RM17TT, RM17TA, RM17TU, and RM17TE

Operating principle

3-phase supply control relays monitor:

- Correct sequence of phases L1, L2, and L3
- Phase loss, including voltage regeneration
- Undervoltage from - 2...- 20% of the supply voltage U_n
- Overvoltage from 2...20% of the supply voltage U_n
- Asymmetry from 5...15% of the supply voltage U_n
- Fault signaling is by LED

Function Diagram

- Output 11-14, 21-24 open
- Output 11-14, 21-24 closed

Voltage switch operation:

- Set the switch to the 3-phase supply voltage U_n .
- The position of this switch is taken into account on energization of the device.
- If the switch position is changed while the device is operating, all the LEDs flash, but the product continues to operate normally with the voltage selected at the time of energization preceding the change of position.
- If the selector switch is returned to the original position selected prior to the last energization, the LEDs return to their normal state.

RM17TT00

Phase + Voltage regeneration

- Sequence of phases L1, L2, and L3
- Phase loss

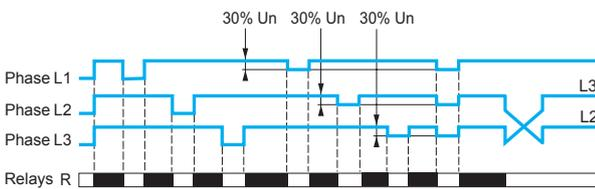

The relay monitors:

- correct sequence of the three phases
- phase loss of at least one of the three phases (U measured $< 0.7 \times U_n$)
 - If a sequencing or phase loss fault is detected, the relay opens instantly.
 - On energization of the device with a detected measured fault, the relay stays open.

RM17TA00

Phase + Asymmetry

- Sequence of phases L1, L2, and L3
- Phase loss
- Asymmetry **Asy**

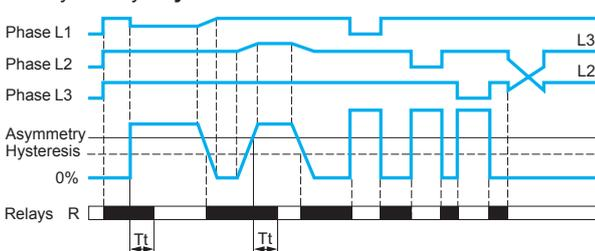

The relay monitors:

- correct sequence of the three phases
- phase loss of at least one of the three phases (U measured < 150 V)
- asymmetry adjustable from 5...15% of U_n
 - If a sequencing or phase loss fault is detected, the relay opens instantly.
 - If an asymmetry fault is detected, the relay opens at the end of the time delay set by the user.
 - On energization of the device with a detected measured fault, the relay stays open.

Note: T_t : time delay after crossing of the threshold (adjustable on front panel).

Zelio Control - Monitoring & Control Relays

Multifunction 3-phase supply control relays
RM17TT, RM17TA, RM17TU, and RM17TE

Operating principle (continued)

RM17TU00

Phase + Undervoltage

- Sequence of phases L1, L2, and L3
- Phase loss

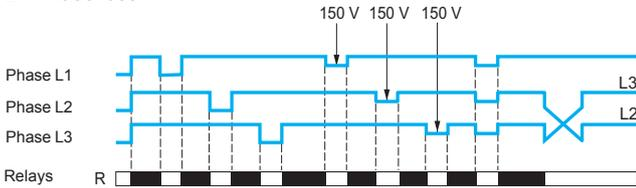

- Undervoltage control $U <$

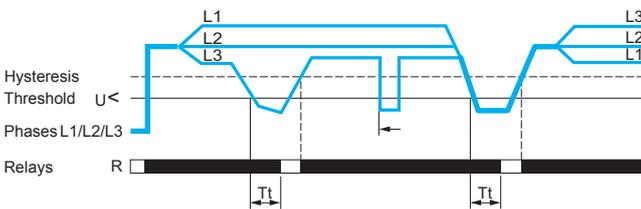

Tt: time delay after crossing of the threshold (adjustable on front panel)

The relay monitors:

- correct sequence of the three phases
- phase loss of at least one of the three phases (U measured < 150 V)
- undervoltage adjustable from $-2 \dots -20\%$ of U_n ($-2 \dots -12\%$ in the range 3×208 V \sim and $-2 \dots -17\%$ in the range 3×220 V \sim due to the minimum voltage 183 V \sim)

- If a sequencing or phase loss fault is detected, the relay opens instantly.
- If a voltage fault is detected, the relay opens at the end of the time delay set by the user.
- On energization of the device with a detected measured fault, the relay stays open.

RM17TE00

Phase + Asymmetry + Undervoltage/overvoltage

- Sequence of phases L1, L2, and L3
- Phase loss
- Asymmetry Asy

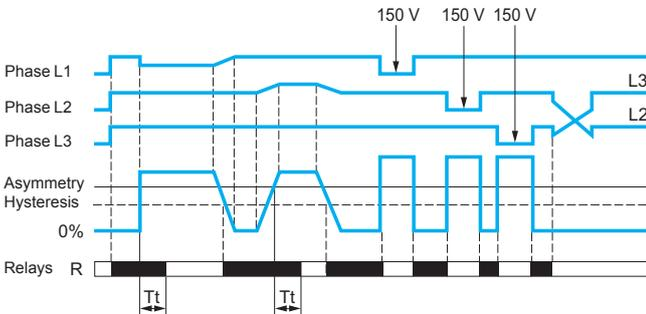

Tt: time delay after crossing of the threshold (adjustable on front panel)

The relay monitors:

- correct sequence of the three phases
- phase loss of at least one of the three phases (U measured < 150 V)
- asymmetry adjustable from $5 \dots 15\%$ of U_n
- the overvoltage and undervoltage difference in window mode, adjustable from $2 \dots 20\%$ of U_n

U_n	208 V	220 V	380, 400, 415, 440 V	480 V
Voltage	$< -12 \dots -2$	$-17 \dots -2$	$-20 \dots -2$	$-20 \dots -2$
threshold (%)	$> +2 \dots +20$	$+2 \dots +20$	$+2 \dots +20$	$+2 \dots +10$

- If a sequencing or phase loss fault is detected, the relay opens instantly.
- If an asymmetry or voltage fault is detected, the relay opens at the end of the time delay set by the user.
- On energization of the device with a detected measured fault, the relay stays open.

- Control of overvoltage and undervoltage in window mode $U > / U <$

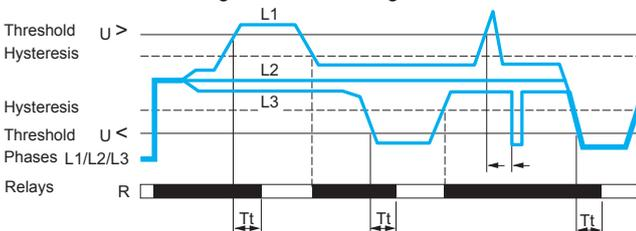

Tt: time delay after crossing of the threshold (adjustable on front panel)

Zelio Control - Monitoring & Control Relays

Multifunction 3-phase supply control relays
RM17TT, RM17TA, RM17TU, and RM17TE



RM17TT00



RM17TA00



RM17TU00



RM17TE00

References

Function	Measurement range	Output	Reference	Weight
	V			kg/lb
<ul style="list-style-type: none"> ■ Phase sequence ■ Phase loss with voltage regeneration 	208...480 ~	1 CO 5 A	RM17TT00	0.080/ 0.176
<ul style="list-style-type: none"> ■ Phase sequence ■ Phase loss ■ Asymmetry 	208...480 ~	1 CO 5 A	RM17TA00	0.080/ 0.176
<ul style="list-style-type: none"> ■ Phase sequence ■ Phase loss ■ Undervoltage 	208...480 ~	1 CO 5 A	RM17TU00	0.080/ 0.176
<ul style="list-style-type: none"> ■ Phase sequence ■ Phase loss ■ Asymmetry ■ Undervoltage and overvoltage in window mode 	208...480 ~	1 CO 5 A	RM17TE00	0.080/ 0.176

Zelio Control – Monitoring & Control Relays

Multifunction 3-phase supply control relays
RM35TF



RM35TF30

Presentation

The RM35TF30 control relay monitors the following on 3-phase supplies:

Functions	RM35TF30
Sequence of phases L1, L2, and L3	
Phase loss	
Overtoltage and undervoltage in window mode	
Asymmetry	

- Function performed
- Function not performed

These control relays:

- Accept different nominal 3-phase voltages: 220... 480 V ~
- Monitor their own power supply measured as a true rms value
- Are designed for clip-on mounting on a 35 mm rail

They feature:

- A sealable cover to help protect the settings
- A control status indicator LED

Applications

- Control for connection of moving equipment (site equipment, agricultural equipment, refrigerated trucks)
- Control against reverse motor operation (lifting, handling, elevators, escalators, etc.)
- Control of sensitive 3-phase supplies
- Emergency power supply switching in abnormal conditions

Description

RM35TF

- 1 Voltage range selector switch (220, 380, 400, 415, 440, and 480 V ~)
- 2 Overtoltage setting potentiometer $>U$
- 3 Undervoltage setting potentiometer $<U$
- 4 Asymmetry threshold setting potentiometer Asy
- 5 Time delay adjustment potentiometer Tt
- 6 Spring for clip-on mounting on 35 mm/1.38 in. rail

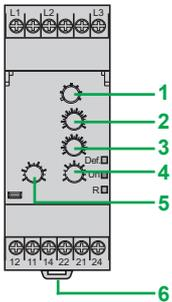

RM35TF

Def. Yellow LED: indicates fault present status (on for asymmetry, flashing for overvoltage, and undervoltage)

Un Green LED: indicates that supply to the product is on

R Yellow LED: indicates relay output status

Operating principle

3-phase supply control relay RM35TF30 monitors:

- Correct sequence of phases L1, L2, and L3
- Phase loss
- Undervoltage and overvoltage in window mode

Function Diagram

- Output 11-14, 21-24 open
- Output 11-14, 21-24 closed

Un	220 V	380, 400, 415, 440 V	480 V
Voltage threshold (%)			
<	- 12...- 2	- 20...- 2	- 20...- 2
>	+ 2...+ 20	+ 2...+ 20	+ 2...+ 10

- Asymmetry from 5... 15% of the supply voltage Un
- LED indication for relay output status and fault detection (except phase disconnection)

■ Voltage switch operation:

- Set the switch to the 3-phase supply voltage Un .
- The position of this switch is only taken into account on energization of the device.
- If the switch position is changed while the device is operating, all the LEDs flash, but the product continues to operate normally with the voltage selected at the time of energization preceding the change of position.
- If the switch is returned to the original position selected prior to the last energization, the LEDs return to their normal state.

Operating principle (continued)

RM35TF

Phase + Overvoltage + Undervoltage in window mode

- Sequence of phases L1, L2, and L3
- Phase loss
- Asymmetry

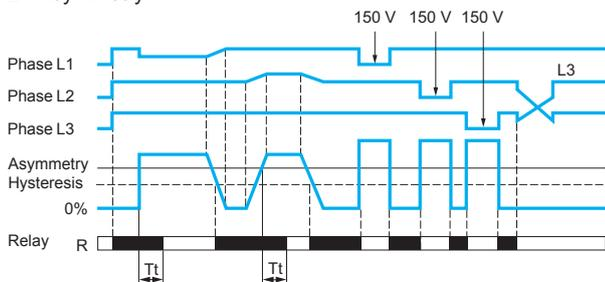

The relay monitors:

- correct sequence of the three phases
- phase loss of at least one of the three phases (U measured < 150 V)
- asymmetry, adjustable from 5 to 15% of U_n
- the undervoltage, adjustable from - 2...- 20% of U_n (- 2...- 12% in the range 3×220 V ~)
- the overvoltage, adjustable from + 2...+ 20% of U_n (+ 2...+ 10% in the range 3×480 V ~ due to the maximum voltage 528 V ~)

- If a sequencing or phase loss fault is detected, the relay opens instantly.
- If an asymmetry or voltage fault is detected, the relay opens at the end of the time delay set by the user.
- On energization of the device with a detected measured fault, the relay stays open.

- Control of overvoltage and undervoltage in window mode <U>

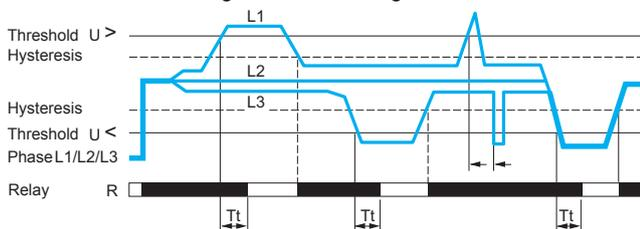

Note: T_t : time delay after crossing of the threshold (adjustable on front panel)

Reference



RM35TF30

Function	Rated 3-phase supply voltage	Output	Reference	Weight
	V			kg/lb
■ Phase sequence	220...480 ~	2 CO 5 A	RM35TF30	0.130/ 0.287
■ Phase loss				
■ Asymmetry				
■ Undervoltage and overvoltage in window mode				

Zelio Control – Monitoring & Control Relays

3-phase voltage control relays
RM17UB3 and RM35UB3



RM35UB3●●●



RM17UB310

Presentation

Voltage measurement and control relays RM35UB330, RM17UB310 and RM35UB3N30 monitor the following, on 3-phase supplies:

Functions	RM35UB330	RM17UB310	RM35UB3N30
Phase loss			
Absence of neutral			
Overvoltage and undervoltage			
Voltage between phases	220...480 V ~	208...480 V ~	
Voltage between phases and neutral			120...277 V ~

- Function performed
- Function not performed

Depending on the model, control relays:

- Monitor their own power supply measured as a true rms value
- Are designed for clip-on mounting on a 35 mm rail

They feature:

- A sealable cover to help protect the settings
- A control status indicator LED

Applications

- Control for connection of moving equipment (site equipment, agricultural equipment, refrigerated trucks)
- Control against reverse motor operation (lifting, handling, elevators, escalators, etc.)
- Control of sensitive 3-phase supplies
- Emergency power supply switching in abnormal conditions

Description

RM35UB330, RM35UB3N30

- 1a Voltage range selector switch (220, 380, 400, 415, 440, and 480 V ~)
- 1b Voltage range selector switch (120, 127, 220, 230, 240, 260, and 277 V ~)
- 2 Overvoltage setting potentiometer >U
- 3 Undervoltage setting potentiometer <U
- 4 Undervoltage threshold delay setting potentiometer Tt2
- 5 Overvoltage threshold delay setting potentiometer Tt1
- 6 Spring for clip-on mounting on 35 mm/1.38 in. rail

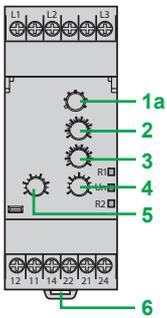

RM35UB330

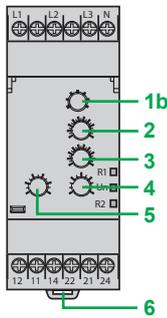

RM35UB3N30

- Un Green LED: indicates that supply to the product is on
- R1 Yellow LED: indicates relay output status. Overvoltage threshold
- R2 Yellow LED: indicates relay output status. Undervoltage threshold

RM17UB310

- 1 Voltage range selector switch (208, 220, 380, 400, 415, 440, and 480 V ~)
- 2 Time delay adjustment potentiometer Tt
- 3 Overvoltage setting potentiometer >U
- 4 Undervoltage setting potentiometer <U
- 5 Spring for clip-on mounting on 35 mm/1.38 in. rail



RM17UB310

- Un Green LED: indicates that supply to the product is on
- R Yellow LED: indicates relay output status

Zelio Control – Monitoring & Control Relays

3-phase voltage control relays
RM17UB3 and RM35UB3

Operating principle

3-phase voltage control relays monitor:

- Undervoltage and overvoltage:

Function Diagram

-  Output 11-14, 21-24 open
-  Output 11-14, 21-24 closed

Un Phase/phase		208 V	220 V	380, 400, 415, 440 V	480 V
RM17UB310	> U (%)	+ 2...+ 20	+ 2...+ 20	+ 2...+ 20	+ 2...+ 10
	< U (%)	- 12...- 2	- 17...- 2	- 20...- 2	- 20...- 2
RM35UB30	> U (%)	–	+ 2...+ 20	+ 2...+ 20	+ 2...+ 10
	< U (%)	–	- 12...- 2	- 20...- 2	- 20...- 2
Un Phase/neutral		120 V	127 V	220, 230, 240, 260 V	277 V
RM35UB3N30	> U (%)	+ 2...+ 20	+ 2...+ 20	+ 2...+ 20	+ 2...+ 20
	< U (%)	- 20...- 2	- 20...- 2	- 20...- 2	- 20...- 2

- Phase loss
- Presence of neutral (RM35UB3N30 only)
- Measurements are made between Phases for RM35UB330 and RM17UB310 and between Phase/Neutral for RM35UB3N30
- Fault signaling is by LED
- RM35UB relays can differentiate between the source of the fault (one LED for overvoltage threshold, one LED for undervoltage threshold)
- Voltage switch operation:
 - Set the switch to the 3-phase supply voltage Un.
 - The position of this switch is only taken into account on energization of the device.
 - If the switch position is changed while the device is operating, all the LEDs flash, but the product continues to operate normally with the voltage selected at the time of energization preceding the change of position.
 - If the switch is returned to the original position selected prior to the last energization, the LEDs return to their normal state.

RM35UB330

Overvoltage/undervoltage control

- Phase loss

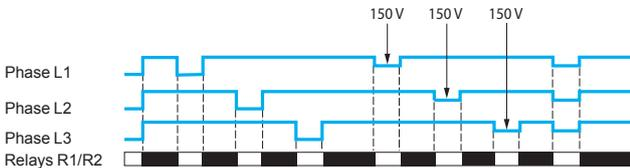

- Overvoltage and undervoltage

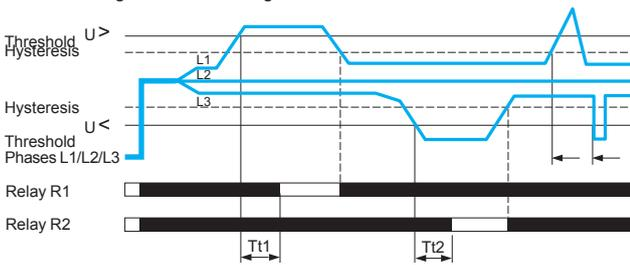

- The relay monitors:

- phase loss (U measured < 150 V)
- the undervoltage
- the overvoltage

- Each threshold has its own independently adjustable time delay from 0.3 to 30 s.

- If a voltage fault is detected, the corresponding relay (one undervoltage output/one overvoltage output) opens at the end of the time delay set by the user.

- If a phase loss is detected, both relays open instantly without waiting for the end of the time delay set by the user.

- On energization of the device with a detected measured fault, the relays stay open.

Note: Tt 1: overvoltage threshold delay (adjustable on front panel)
Tt 2: undervoltage threshold delay (adjustable on front panel)

Zelio Control – Monitoring & Control Relays

3-phase voltage control relays
RM17UB3 and RM35UB3

Operating principle (continued)

RM35UB3N30

Overvoltage/undervoltage + absence of neutral control

□ Phase loss

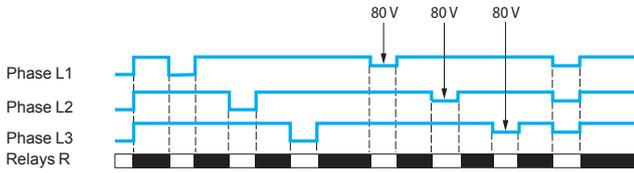

□ Overvoltage and undervoltage

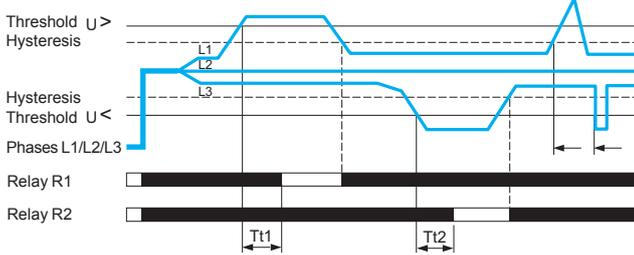

- The relay monitors:
 - presence of the neutral
 - the undervoltage
 - the overvoltage
 - phase loss (U measured < 80 V)
- Each threshold has its own independently adjustable time delay from 0.3 to 30 s.
- If a voltage fault is detected, the corresponding relay (one undervoltage output/one overvoltage output) opens at the end of the time delay set by the user.
- In the absence of either neutral or phase, both relays open instantly without waiting for the end of the time delay set by the user.
- On energization of the device with a detected measured fault, the relays stay open.

*Note: Tt 1: overvoltage threshold delay (adjustable on front panel)
Tt 2: undervoltage threshold delay (adjustable on front panel)*

RM17UB310

Overvoltage/undervoltage control

□ Phase loss

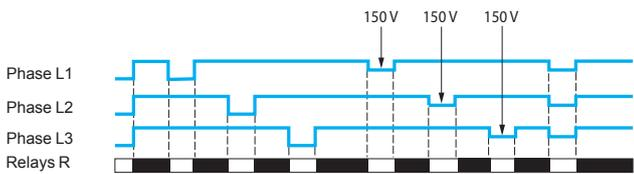

□ Overvoltage and undervoltage

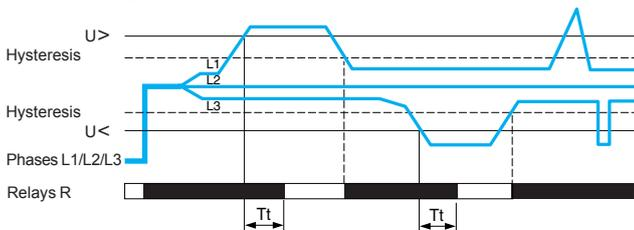

- The relay monitors:
 - the undervoltage
 - the overvoltage
 - phase loss (U measured < 150 V)
- An adjustable time delay from 0.3 to 30 s allows inhibition of the output relay if a transient fault occurs.
- If a voltage fault is detected, the relay opens at the end of the time delay set by the user.
- On energization of the device with a detected measured fault, the relay stays open.
- If phase loss is detected, the relay opens instantly.

Note: Tt: overvoltage and undervoltage threshold delay (adjustable on front panel)

Zelio Control – Monitoring & Control Relays

3-phase voltage control relays
RM17UB3 and RM35UB3



RM35UB330



RM17UB310



RM35UB3N30

References

Function	Measurement range	Output	Reference	Weight
V				
kg/lb				
■ Overvoltage and undervoltage between phases	220...480 ~ (Phase-phase)	1 CO +1 CO 1 per threshold 5 A	RM35UB330	0.130/ 0.287
	208...480 ~ (Phase-phase)	1 CO 5 A	RM17UB310	0.080/ 0.176
■ Overvoltage and undervoltage between phases and neutral	120...277 ~ (Phase-neutral)	1 CO +1 CO 1 per threshold 5 A	RM35UB3N30	0.130/ 0.287
■ Absence of neutral				

Zelio Control – Monitoring & Control Relays

3-phase supply and motor temperature control relays
RM35TM



RM35TM50MW



RM35TM250MW

Presentation

RM35 Zelio multifunction control relays monitor the following functions on 3-phase supplies:

Functions	RM35TM50MW	RM35TM250MW
Sequence of phases L1, L2, and L3		
Phase loss		
Motor temperature via PTC probe		
Selection (with or without memory)		
Test/Reset button		

- Function performed
- Function not performed

Depending on the model, control relays:

- Accept different nominal 3-phase voltages: 208...480 V ~
- Have phase and temperature control functions that are independent of one another
- Detect line breaks or short-circuit of the temperature probes
- Selection (with or without memory) and Test/Reset function is available
- Are designed for clip-on mounting on a 35 mm rail

They feature:

- A sealable cover to help protect the settings
- A control status indicator LED

Applications

- Control for connection of moving equipment (site equipment, agricultural equipment, refrigerated trucks)
- Control against reverse motor operation (lifting, handling, elevators, escalators, etc.)
- Control of sensitive 3-phase supplies
- Emergency power supply switching in abnormal conditions

Description

RM35TM50MW, RM35TM250MW

- 1 Spring for clip-on mounting on 35 mm/1.38 in. rail
- 2 Temperature contact (11-14)
- 3 Phase contact (21-24)
- 4 Configuration: selection of temperature control operating mode (with or without memory) **Memory - No Memory**
- 5 Pushbutton (activation of temperature control) **Test/Reset**

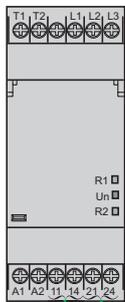

RM35TM50MW

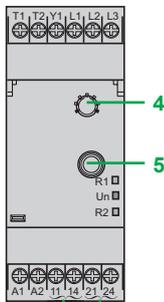

RM35TM250MW

- <V> Yellow LED: relay output status indicator
- Un Green LED: power ON indicator
- Yellow LED: relay output status indicator

Zelio Control – Monitoring & Control Relays

3-phase supply and motor temperature control relays
RM35TM

Operating principle

Relays RM35TM50MW and RM35TM250MW monitor:

- Status of the 3-phase supply
- Temperature of motors with embedded PTC probes

The 3-phase supply control function monitors:

- Correct sequence of phases L1, L2, and L3
- Phase loss

Function Diagram

-  Power supply off
-  Power supply on
-  Output 11-14, 21-24 open
-  Output 11-14, 21-24 closed

RM35TM50MW/RM35TM250MW

3-phase supply control

- Sequence of phases L1, L2, and L3
- Phase loss

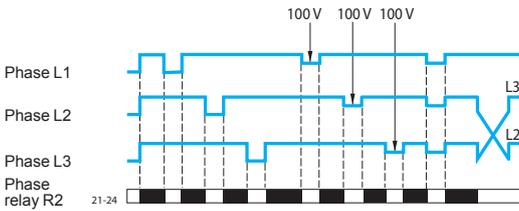

- As soon as phase sequence (L1, L2, and L3) and phase presence are considered to be correct, the output relay contact closes and LED R2 is lit.
- If total failure or drop in amplitude of a phase (U measured < 100 V) or inversion of phase sequence is detected, the output relay contact opens and LED R2 goes out.
- The result of the control is indicated by the status of output relay R2, NO contact 21-24 is open in the event of a fault.

Temperature control

- Motor temperature control via PTC probe

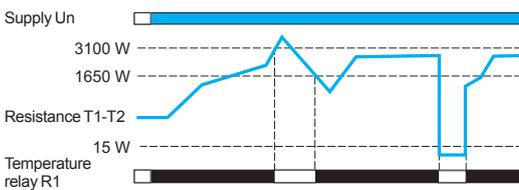

- The temperature control relay can take up to 6 PTC (positive temperature coefficient) probes wired in series between terminals T1 and T2.
- A fault is declared when the resistance of the temperature sensing circuit exceeds 3100 Ω.
- Return to normal status is detected when the resistance is once again below 1650 Ω.
- The result of the control is indicated by the status of the “temperature” output relay, NO contact 11-14 is open in the event of a fault.
- Opening of the thermal sensing circuit, which has the same effect as a high temperature (resistance exceeds 3100 Ω), is therefore interpreted as a fault.
- Total short-circuiting of the temperature probe(s), detected when resistance is less than 15 W ± 5 W, is treated as a fault.
- LED R1 is on when the temperature is correct.

Operating principle (continued)

RM35TM250MW

Configuration

This configuration is considered when relay RM35TM250MW is energized.

- Set the switch to the required operating mode:
 - Temperature control without memory
 - Temperature control with memory
- On energization, placing the switch in one of the five intermediate positions holds the relay in the open contact state and the detected error is signaled by simultaneous flashing of the LEDs.
- The position of the mode selector switch is taken into account on energization.
- Any modification of its position during operation has no effect - the active configuration may therefore be different from that indicated by the switch - the RM35TM250MW operates normally but the change in configuration is signaled by simultaneous flashing of the three LEDs.

Motor temperature control via PTC probe with memory

- Memory

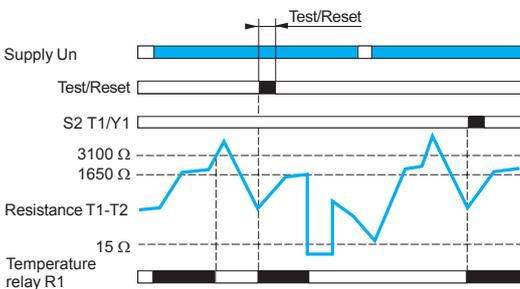

- Relay RM35TM250MW has a selector switch which allows the temperature control operating mode to be configured with or without memory.
- In “memory” mode, when a fault is detected, the “temperature” relay locks in the open position.
- As soon as the temperature returns to the correct value, the relay can be unlocked (reset), either by pressing the “Test/Reset” button (for at least 200 ms), or by closing a volt-free contact (for at least 200 ms) between terminal Y1 and T1 (without a parallel load).
- Relay RM35TM250MW can also be reset by switching off the power (see reset time).

Use of “Test/Reset” button

- No Memory

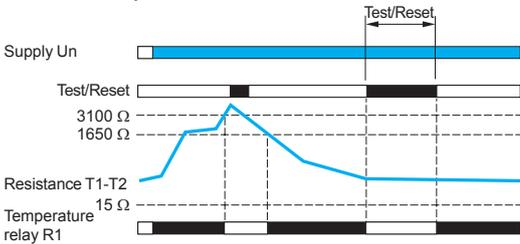

- Relay version RM35TM250MW has a “Test/Reset” button which can be used to check that the temperature control function is working correctly and to reset this function after locking in “memory” mode.
- The press and release times are 50 ms for both functions.
- When the temperature is normal, pressing the “Test/Reset” button simulates overheating, the “temperature” output relay contact is open and the <V< LED is off.
- If “memory” mode is not active, “fault” indication is maintained for as long as the button is pressed.
- If “memory” mode is active, “fault” indication is locked and the button needs to be released and pressed again to reset the function.

- Memory

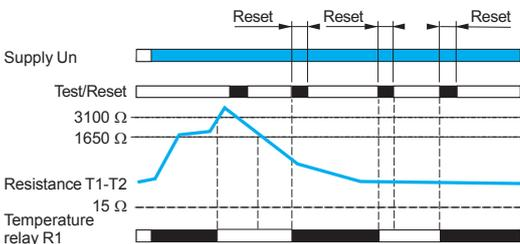

- In “memory” mode, when a fault has been detected and the temperature has returned to normal, the “temperature” control relay can be unlocked (reset) by pressing the “Test/Reset” button.

Zelio Control – Monitoring & Control Relays

3-phase supply and motor temperature control relays
RM35TM



RM35TM50MW



RM35TM250MW

References

Function	Supply voltage	Measurement range	Output	Reference	Weight
	V	V			kg/lb
■ Phase sequence	24...240 ~	208...480 ~	2 NO	RM35TM50MW	0.120/
■ Phase loss			5 A		0.264
■ Motor temperature via PTC probe					

■ Phase sequence	24...240 ~	208...480 ~	2 NO	RM35TM250MW	0.120/
■ Phase loss			5 A		0.264
■ Motor temperature via PTC probe					
■ Selection (with or without memory)					
■ "Test/Reset" button					

Zelio Control – Monitoring & Control Relays

1-phase voltage control relays
RM17UAS and RM17UBE



RM17UBE●●

Presentation

1-phase DC voltage measurement and control relays RM17UAS●● and RM17UBE●● monitor:

Functions	RM17 UAS14	RM17 UAS15	RM17 UAS16	RM17 UBE15	RM17 UBE16
Overvoltage or undervoltage					
Overvoltage and undervoltage (window mode)					
Ranges controlled	9...15 $\overline{\sim}$	65...260 $\overline{\sim}$	20...80 $\overline{\sim}$	65...260 $\overline{\sim}$	20...80 $\overline{\sim}$

- Function performed
- Function not performed

Depending on the model, control relays:

- Allow selection of operating mode
- Monitor their own power supply measured as a true rms value
- Are designed for clip-on mounting on a \perp rail

They feature:

- A sealable cover to help protect the settings
- A control status indicator LED

Applications

- Protection of electronic or electromechanical devices against overvoltage and undervoltage
- Emergency power supply switching at abnormal conditions

Description

RM17UAS●●

- 7 Configuration: selection of operating mode <U / >U, Memory - No Memory
- 8 Setting potentiometer
- 9 Hysteresis adjustment potentiometer H
- 10 Time delay setting potentiometer Tt
- 11 Spring for clip-on mounting on 35 mm / 1.38 in. \perp rail

RM17UBE1●

- 6 Maximum voltage range selection and setting potentiometer
- 7 Minimum voltage range selection and setting potentiometer
- 8 Time delay setting potentiometer Tt
- 9 Spring for clip-on mounting on 35 mm / 1.38 in. \perp rail

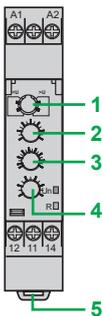

RM17UAS●●

Un Green LED: indicates that supply to the product is on
R Yellow LED: indicates relay output status

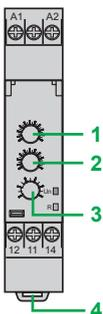

RM17UBE1●

Un Green LED: indicates that supply to the product is on
R Yellow LED: indicates relay output status

Zelio Control – Monitoring & Control Relays

1-phase voltage control relays
RM17UAS and RM17UBE

Operating principle

Voltage control relays RM17UAS and RM17UBE monitor:

- Voltage of 1-phase and DC supplies
- RM17UAS●● relays support two operating modes:
 - Overvoltage or undervoltage
 - Fault memory selected or not
- An adjustable time delay, on crossing the thresholds, provides immunity to transients, and helps prevent spurious triggering of the output relay
- Fault signaling is by LED

Function Diagram

-  Power supply off
-  Power supply on
-  Output 11-14, 21-24 open
-  Output 11-14, 21-24 closed

RM17 UAS14/UAS15/UAS16

The operating mode is determined by a switch:

- Undervoltage with or without memory
- Overvoltage with or without memory

The position of the configuration switch and the operating mode is read by the product on energization:

- If the configuration switch is set to an unacceptable position, the product detects a fault, the output relay stays open and the LEDs flash to indicate the position error.
- If the switch position is changed while the device is operating, all the LEDs flash, but the product continues to operate normally with the function selected at the time of energization preceding the change of position.
- If the configuration switch is returned to the original position selected prior to the last energization, the LEDs return to their normal state.

The undervoltage or overvoltage threshold value is set by a graduated potentiometer clearly indicating the voltage **Un** to be monitored. The hysteresis is adjusted by a potentiometer graduated from 5...20% of the threshold setting. The hysteresis value must not exceed the limit values of the measuring range.

Undervoltage/Overvoltage without memory

- Undervoltage control $U <$, No Memory

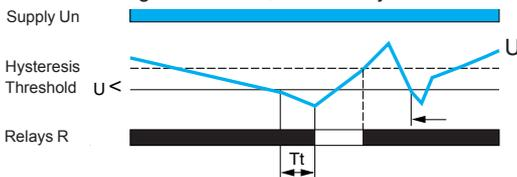

If the controlled voltage falls below the threshold setting for a time greater than that set on the front panel (0.1...10 s), the output relay opens and the R LED goes off. As soon as the voltage returns to a value above (or below) the threshold setting minus (or respectively plus) the hysteresis, the relay instantly closes.

- Overvoltage control $U >$, No Memory

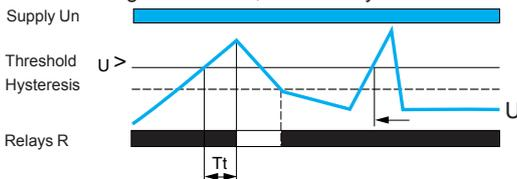

If the controlled voltage exceeds the threshold setting for a time greater than that set on the front panel (0.1...10 s), the output relay opens and the R LED goes off. As soon as the voltage returns to a value below the threshold setting plus the hysteresis, the relay instantly closes.

Zelio Control – Monitoring & Control Relays

1-phase voltage control relays
RM17UAS and RM17UBE

Operating principle (continued)

RM17 UAS14/UAS15/UAS16 (continued)

Undervoltage/Overvoltage with memory

□ Undervoltage control $U <$, Memory

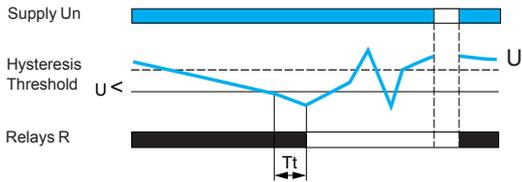

If “Memory” mode is selected, the relay opens when crossing of the threshold is detected and then stays in that position. The power needs to be switched off to reset the product.

□ Overvoltage control $U >$, Memory

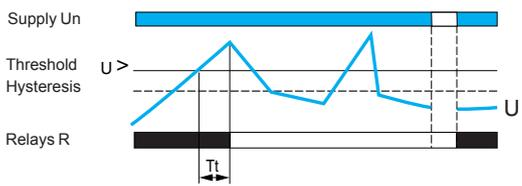

Note: Tt : time delay after crossing of the threshold

RM17 UBE15/UBE16

Overvoltage + undervoltage control in window mode

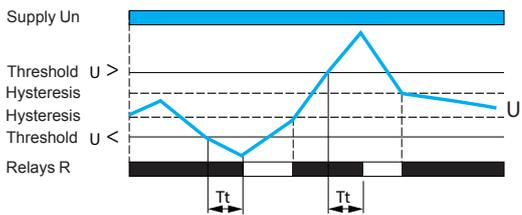

These relays operate in window mode where they check that the controlled voltage stays between a minimum threshold and a maximum threshold.

- The undervoltage or overvoltage threshold values are set by two graduated potentiometers clearly indicating the voltage U_n to be monitored. The hysteresis is fixed at 3% of the threshold setting.
- If the controlled voltage exceeds the high threshold setting, or falls below the low threshold setting for a time greater than that set on the front panel (0.1 ... 10 s), the output relay opens and the R LED goes out. During the time delay, this LED flashes.
- As soon as the voltage falls below the high threshold setting value minus the hysteresis, or rises above the low threshold setting value plus the hysteresis, the relay instantly closes.
- On energization of the device with a detected measured fault, the relay stays open.

Note: Tt : time delay after crossing of the threshold

Zelio Control – Monitoring & Control Relays

1-phase voltage control relays
RM17UAS and RM17UBE



RM17UBE16



RM17UBE15

References

Function	Ranges controlled	Output	Reference	Weight
	V			kg/lb
■ Overvoltage or undervoltage	9...15 $\overline{\sim}$	1 CO 5 A	RM17UAS14	0.080/ 0.176
	20...80 $\overline{\sim}$	1 CO 5 A	RM17UAS16	0.080/ 0.176
	65...260 $\overline{\sim}$	1 CO 5 A	RM17UAS15	0.080/ 0.176
■ Overvoltage and undervoltage in window mode	20...80 $\overline{\sim}$	1 CO 5 A	RM17UBE16	0.080/ 0.176
	65...260 $\overline{\sim}$	1 CO 5 A	RM17UBE15	0.080/ 0.176

Zelio Control - Monitoring & Control Relays

Multifunction 1-phase voltage control relays
RM35UA



RM35UA1 MW

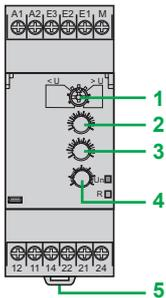

RM35 UA11MW/UA12MW/UA13MW

Un Green LED: indicates that supply to the product is on
R Yellow LED: indicates relay output status

Presentation

Multifunction voltage control relays RM35UA1 MW monitor both AC and DC voltages.

Functions	RM35UA11MW	RM35UA12MW	RM35UA13MW
Overvoltage or undervoltage (with or without memory)			
Range controlled	0.05...5 V	1...100 V	15...600 V

- Function performed
- Function not performed

Depending on the model, the control relays allow:

- Automatic $\overline{\sim}$ or \sim recognition
- Measurement ranges from 0.05 V to 600 V
- Selection between overvoltage and undervoltage
- Measurement as a true rms value
- Selectable memory function
- Clip-on mounting on a $\overline{\sim}$ rail

They feature:

- A sealable cover to help protect the settings
- A control status indicator LED

Applications

- DC motor overspeed control
- Battery monitoring
- Monitoring of AC or DC supplies
- Speed monitoring (with tacho-generator)

Description

RM35 UA11MW/UA12MW/UA13MW

- 1 Configuration: selection of operating mode $<U / >U$, (with or without memory)
Memory - No Memory
- 2 Voltage threshold setting potentiometer **U Value**
- 3 Hysteresis adjustment potentiometer **H**
- 4 Time delay setting potentiometer **Tt**
- 5 Spring for clip-on mounting on 35 mm / 1.38 in. $\overline{\sim}$ rail

Operating principle

Multifunction voltage relays RM35UA1 MW:

- Automatically recognize the form of $\overline{\sim}$ or \sim (50 or 60 Hz) signal
- Fault signaling is by LED

Function Diagram

- Power supply off
- Power supply on
- Output 11-14, 21-24 open
- Output 11-14, 21-24 closed

RM35 UA11MW/UA12MW/UA13MW

The operating mode is selected by using a switch:

- Undervoltage with or without memory
- Overvoltage with or without memory

The position of the switch and the operating mode is read by the product on energization:

- If the switch is set to an unacceptable position, the product detects a fault, the output relay stays open and the LEDs flash to indicate the position error.
- If the switch position is changed while the device is operating, all the LEDs flash, but the product continues to operate normally with the function selected at the time of energization preceding the change of position.
- If the configuration switch is returned to the original position selected prior to the last energization, the LEDs return to their normal state.

The undervoltage or overvoltage threshold value is set by a potentiometer graduated as a percentage of the scale value of **Un** to be monitored. The hysteresis is adjusted by a potentiometer graduated from 5...50% of the threshold setting. The hysteresis value must not exceed the limit values of the measuring range.

Operating principle (continued)

RM35 UA11MW/UA12MW/UA13MW

Overvoltage without memory

■ Overvoltage control $> U$, without memory

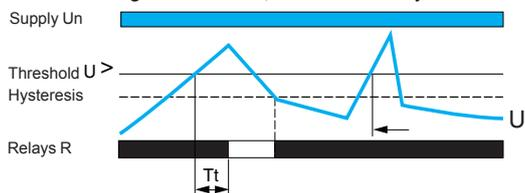

If the voltage controlled exceeds the threshold setting for a time greater than that set on the front panel (0.3...30 s), the output relay opens and the **R** LED goes off. During the time delay, this LED flashes. As soon as the voltage drops below the value of the threshold setting, minus the hysteresis, the relay instantly closes.

Note: T_t : time delay after crossing of the threshold (adjustable on front panel)

Undervoltage without memory

■ Undervoltage control $< U$, without memory

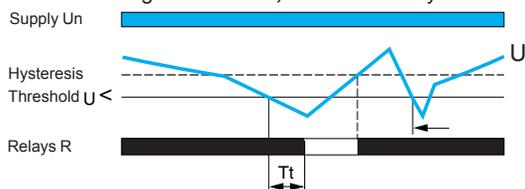

If the voltage controlled falls below the threshold setting for a time greater than that set on the front panel (0.3...30 s), the output relay opens and the **R** LED goes off. During the time delay, this LED flashes. As soon as the voltage rises above the value of the threshold setting plus the hysteresis, the relay instantly closes.

Note: T_t : time delay after crossing of the threshold (adjustable on front panel)

Overvoltage/undervoltage with memory

■ Undervoltage control $< U$, with memory

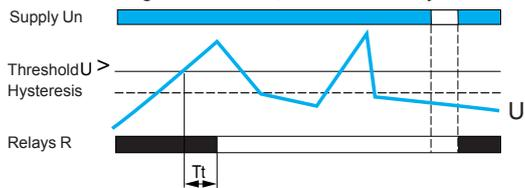

If "Memory" mode is selected, the relay opens when crossing of the threshold is detected and then stays in that position. The power needs to be switched off to reset the product.

■ Undervoltage control $< U$, with memory

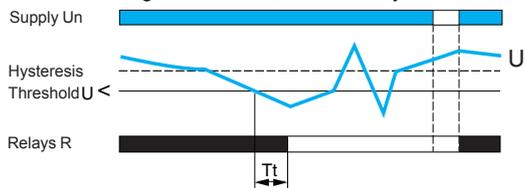

Note: T_t : time delay after crossing of the threshold (adjustable on front panel)

References



Function	Range controlled	Supply voltage	Output	Reference	Weight
	V	V			kg/lb
■ Overvoltage or undervoltage	0.05...5	24...240 ~	2 CO 5 A	RM35UA11MW	0.130/ 0.287
	1...100	24...240 ~	2 CO 5 A	RM35UA12MW	0.130/ 0.287
	15...600	24...240 ~	2 CO 5 A	RM35UA13MW	0.130/ 0.287

Zelio Control - Monitoring & Control Relays

1-phase voltage control relays
RM22UA and RM22UB



RM22UA21MR



RM22UA31MR

Presentation

RM22UA and RM22UB 1-phase or DC voltage control relays monitor the following functions:

Functions	RM22	UA2•MR	UA3•MR	UA33MT	UB34
Overvoltage (without memory)					
Overvoltage or undervoltage (with/without memory)					
Overvoltage and undervoltage (window mode)					

- Function performed
- Function not performed

RM22 control relays allow:

- Automatic AC or DC recognition
- Selection between overvoltage and undervoltage
- Monitoring of their own supply voltage measured as a true rms value
- Selectable memory function
- Clip-on mounting on a \bar{L} rail

They feature a:

- Dial pointer LED indicator for relay power ON status
- Relay output status LED
- A sealable cover to help protect the settings
- A control status indicator LED

Applications

- Protection of electronic or electromechanical devices against overvoltage and undervoltage
- Emergency power supply switching in abnormal conditions
- DC motor overspeed control
- Monitoring of AC or DC supplies
- Battery and speed monitoring (with tacho-generator)

Description

RM22UA2•MR, RM22UA3•MR, RM22UA33MT, RM22UB34

- 1 Configuration: selection of operating mode <U> (undervoltage), >U> (overvoltage), >U> (overvoltage and undervoltage), MEMORY - NO MEMORY (with or without memory)
- 2a Voltage threshold setting potentiometer U value
- 2b Undervoltage setting potentiometer <U>
- 2c Overvoltage setting potentiometer >U>
- 3 Time delay adjustment potentiometer Tt
- 4a Hysteresis adjustment potentiometer Hys
- 4b Hysteresis/overvoltage and undervoltage window mode adjustment potentiometer Hys/>U>
- 5 Diagnostic button
- 6 Configuration: selection of On-delay or Off-delay



RM22UA2•MR

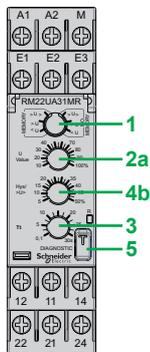

RM22UA3•MR

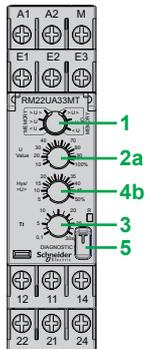

RM22UA33MT

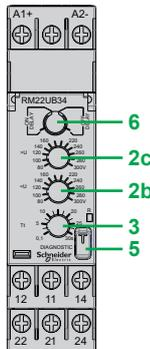

RM22UB34

R Yellow LED: indicates relay output status

Operating principle

- 1-phase voltage control relays monitor:
- the voltage of 1-phase and DC supplies
 - their own supply voltage for the RM22UB model

An adjustable time delay on threshold crossing, provides immunity to transients, and helps prevent spurious triggering of the output relay.

Function Diagram

-  Power supply off
-  Power supply on
-  Output 11-14, 21-24 open
-  Output 11-14, 21-24 closed

RM22 UA2•MR/UA3•MR/UA33MT

The operating mode is determined by the user:

- Undervoltage with or without memory
- Overvoltage with or without memory

The position of the configuration switch and the operating mode is read by the product on energization:

- If the configuration switch is set to an unacceptable position, the product detects a fault, the output relay stays open, and the LEDs flash to indicate the position error.
- If the configuration switch position is changed while the device is operating, all the LEDs flash, but the product continues to operate normally with the function selected at the time of energization preceding the position change.
- If the configuration switch is returned to the original position selected prior to the last energization, the LEDs return to their normal state.

The undervoltage or overvoltage threshold value is set by means of a potentiometer graduated as a percentage of the scale value of U to be monitored. The hysteresis is adjusted by means of a potentiometer graduated from 5...50% of the threshold setting. The hysteresis value must not exceed the limit values of the measuring range.

Overvoltage without memory

- Overvoltage control $> U$, without memory

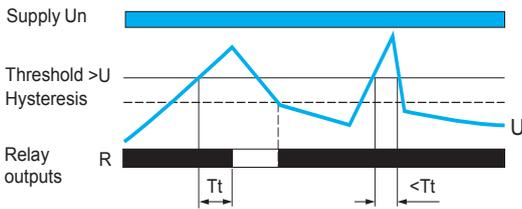

If the controlled voltage exceeds the threshold setting for a time greater than that set on the front panel (0.1...30 s), the output relay opens and the R LED goes off. During the time delay, this LED flashes.

As soon as the voltage drops below the value of the threshold setting minus the hysteresis, the relay instantly closes.

Undervoltage without memory

- Undervoltage control $< U$, without memory

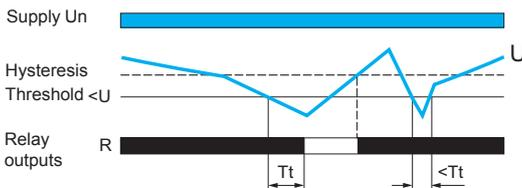

If the controlled voltage falls below the threshold setting for a time greater than that set on the front panel (0.1...30 s), the output relay opens and the R LED goes off. During the time delay, this LED flashes.

As soon as the voltage rises above the value of the threshold setting plus the hysteresis, the relay instantly closes.

Zelio Control - Monitoring & Control Relays

1-phase voltage control relays
RM22UA and RM22UB

Operating principle (continued)

RM22 UA2•MR/UA3•MR/UA33MT (continued)

Overvoltage/undervoltage with memory

- Overvoltage control $> U$, with memory

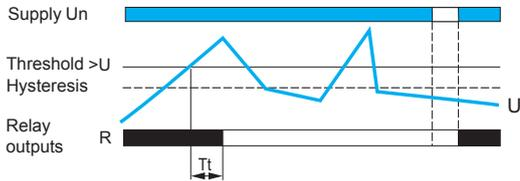

If "Memory" mode is selected, the relay opens when crossing of the threshold is detected and then stays in that position. The power has to be switched off to reset the product.

Note: T_t : time delay after crossing of the threshold

- Undervoltage control $< U$, with memory

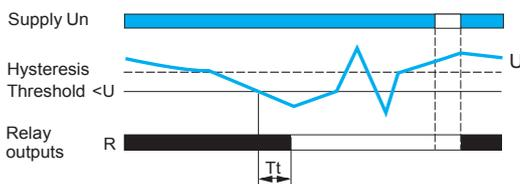

RM22 UA3•MR/UA33MT/UB34

Overvoltage + undervoltage control relay in window mode

- Overvoltage and undervoltage control in window mode $<U<$

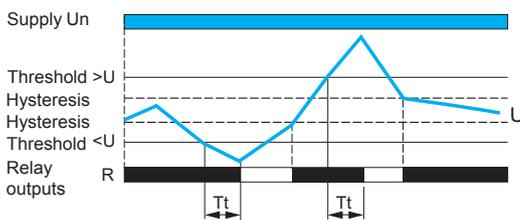

These relays operate in window mode where they check that the controlled voltage stays between a minimum and a maximum threshold.

- The undervoltage or overvoltage threshold values are set by means of two graduated potentiometers clearly indicating the U_n to be monitored. The hysteresis is fixed at 5% of the threshold setting.
- If the controlled voltage exceeds the high threshold setting or falls below the low threshold setting for a time greater than that set on the front panel (0.1...30 s), the output relay opens and the R LED goes off. During the time delay, this LED flashes.
- As soon as the voltage falls below the high threshold setting value minus the hysteresis, or rises above the low threshold setting value plus the hysteresis, the relay instantly closes.
- On energization of the device with a detected measured fault, the relay stays open.

Note: T_t : time delay after crossing of the threshold

Zelio Control - Monitoring & Control Relays

1-phase voltage control relays
RM22UA and RM22UB



RM22UA23MR



RM22UA33MR



RM22UA33MT



RM22UB34

References

Function	Rated supply voltage V	Measurement range V	Time delay	Output	Reference	Weight kg/lb
■ Overvoltage without memory	24...240 ~	0.05...5 ~	No	2 CO 8 A	RM22UA21MR	0.110/ 0.242
	24...240 ~	1...100 ~	No	2 CO 8 A	RM22UA22MR	0.110/ 0.242
	24...240 ~	15...500 ~	No	2 CO 8 A	RM22UA23MR	0.110/ 0.242
■ Overvoltage or undervoltage with/without memory	24...240 ~	0.05...5 ~	Off delay (0.1...30 s)	2 CO 8 A	RM22UA31MR	0.110/ 0.242
	■ Overvoltage and undervoltage in window mode with memory	24...240 ~	1...100 ~	Off delay (0.1...30 s)	2 CO 8 A	RM22UA32MR
24...240 ~		15...500 ~	Off delay (0.1...30 s)	2 CO 8 A	RM22UA33MR	0.110/ 0.242
380...415 ~		15...500 ~	Off delay (0.1...30 s)	2 CO 8 A	RM22UA33MT	0.110/ 0.242
■ Overvoltage and undervoltage in window mode without memory	110...240 ~	80...300 ~	On/Off delay (0.1...30 s)	2 CO 8 A	RM22UB34	0.090/ 0.198

Zelio Control - Monitoring & Control Relays

1-phase current control relays with integrated current transformer
RM17JC



RM17JC00MW

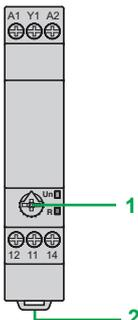

RM17JC00MW

Un Green LED: indicates that supply to the product is on

R Yellow LED: indicates relay output status

Presentation

The control relay **RM17JC00MW** is designed to monitor \sim currents.

Functions	RM17JC00MW
Overcurrent (without memory)	

- Function performed
- Function not performed

These control relays allow:

- Integrated current transformer
- Measurement range 2...20 A
- Choice of action on the output relay
- Clip-on mounting on a \sqcup rail

They feature a control status indicator LED.

Applications

- Load state control of motors and generators
- Control of current drawn by a 3-phase motor
- Monitoring of heating or lighting circuits
- Control of pump draining (undercurrent)
- Control of overtorque (crushers)
- Monitoring of electromagnetic brakes or clutches

Description

RM17JC00MW

- 1 Overcurrent setting potentiometer
- 2 Spring for clip-on mounting on 35 mm/1.38 in. \sqcup rail

Zelio Control - Monitoring & Control Relays

1-phase current control relays with integrated current transformer
RM17JC

Operating principle

Control relay **RM17JC00MW** is:

- equipped with an integrated current transformer
- fault signaling is by LED

Function Diagram

-  Power supply off
-  Power supply on

RM17JC00MW

Overcurrent detection

Overcurrent detection > I

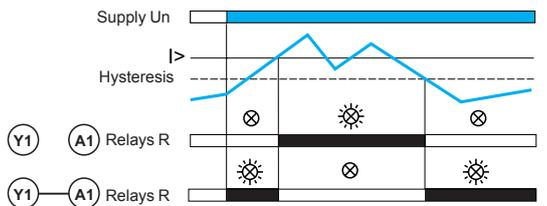

- Relay **RM17JC00MW** controls overcurrent.
- The relay closes when the current exceeds the threshold setting on the front panel and opens when it drops below the threshold minus the hysteresis.
- When terminal Y1 is linked to A1 (+), the output is reversed. The relay opens when the current exceeds the threshold setting on the front panel and closes again when it drops below the hysteresis value.

Reference

PF153412A



RM17JC00MW

Function	Supply	Measurement range	Output	Reference	Weight
	V	A			kg/lb
■ Overcurrent	24...240 ~	2...20	1 CO 5 A	RM17JC00MW	0.110/ 0.243

Zelio Control - Monitoring & Control Relays

1-phase current control relays
RM22JA and RM35JA



RM22JA21MR



RM35JA32MT

Presentation

RM22JA and RM35JA multifunction current control relays monitor the following functions:

Functions	RM22JA21MR	RM22JA31MR	RM35JA 32MR/32MT
Overcurrent (without memory)			
Overcurrent (with/without memory)			
Undercurrent (with/without memory)			
Overcurrent and undercurrent (with/without memory) (window mode)			

- Function performed
- Function not performed

These control relays enable:

- Automatic ~ or --- recognition
- Selection between overcurrent and undercurrent
- Measurement as a true rms value
- Selectable memory function
- Clip-on mounting on a rail

They feature:

- Dial pointer LED indicator for relay power ON status
- Relay output status LED
- A sealable cover to help protect the settings
- A control status indicator LED

Applications

- Excitation control of DC machines
- Load state control of motors and generators
- Control of current drawn by a 3-phase motor
- Monitoring of heating or lighting circuits
- Control of pump draining (undercurrent)
- Control of overtorque (crushers)
- Monitoring of electromagnetic brakes or clutches

Description

RM22JA21MR, RM22JA31MR, RM35JA32MR, RM35JA32MT

- 1 Configuration: selection of operating mode <I (undercurrent), >I (overcurrent), >I> (overcurrent and undercurrent), MEMORY - NO MEMORY (with or without memory)
- 2 Current threshold setting potentiometer I%
- 3a Hysteresis adjustment potentiometer Hys
- 3b Hysteresis/overcurrent and undercurrent window mode adjustment potentiometer Hys/>I>
- 4 Time delay adjustment potentiometer Tt
- 5 Diagnostic button
- 6 Overcurrent setting potentiometer >I

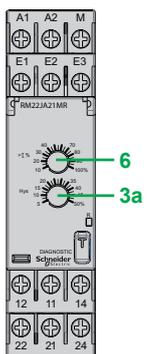

RM22JA21MR

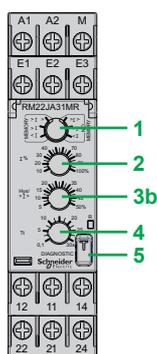

RM22JA31MR

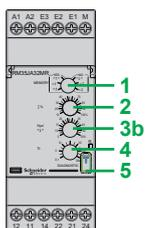

RM35JA32MR

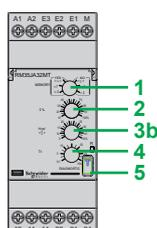

RM35JA32MT

R Yellow LED: indicates relay output status

Operating principle

Current control relays monitor the current of 1-phase and DC supplies.

An adjustable time delay on threshold crossing provides immunity to transients, helping prevent spurious triggering of the output relay.

Function Diagram

-  Power supply off
-  Power supply on
-  Output 11-14, 21-24 open
-  Output 11-14, 21-24 closed

RM22JA•1MR/RM35JA32M•

The operating mode is determined by the user:

- Undercurrent with or without memory
- Overcurrent with or without memory

The position of the configuration switch and the operating mode is read by the product on energization:

- If the configuration switch is set to an unacceptable position, the product detects a fault, the output relay stays open and the LEDs flash to indicate the position error.
- If the configuration switch position is changed while the device is operating, all the LEDs flash, but the product continues to operate normally with the function selected at the time of energization preceding the change of position.
- If the configuration switch is returned to the original position selected prior to the last energization, the LEDs return to their normal state.

The undercurrent or overcurrent threshold value is set by means of a potentiometer graduated as a percentage of the scale value of I to be monitored. The hysteresis is adjusted by means of a potentiometer graduated from 5...50% of the threshold setting. The hysteresis value must not exceed the limit values of the measuring range.

Overcurrent/Undercurrent without memory

- Overcurrent detection $>I$, without memory

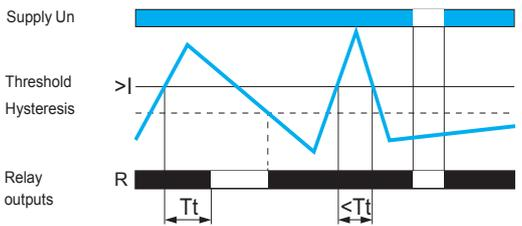

If the controlled current exceeds the threshold setting for a time greater than that set on the front panel (0.1...30 s), the output relay opens and the R LED goes off. During the time delay, this LED flashes.

As soon as the current drops below the value of the threshold setting minus the hysteresis, the relay instantly closes.

- Undercurrent detection $<I$, without memory

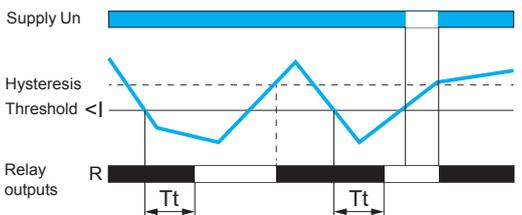

If the controlled current falls below the threshold setting for a time greater than that set on the front panel (0.1...30 s), the output relay opens and the R LED goes off. During the time delay, this LED flashes.

As soon as the current rises above the value of the threshold setting plus the hysteresis, the relay instantly closes.

Note: T_t : time delay after crossing of the threshold

Zelio Control - Monitoring & Control Relays

1-phase current control relays
RM22JA and RM35JA

Operating principle (continued)

RM22JA•1MR/RM35JA32M• (continued)

Overcurrent/Undercurrent with memory

Overcurrent $>I$, with memory

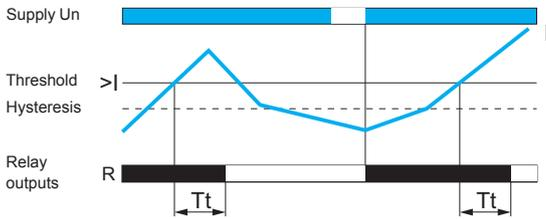

If "Memory" mode is selected, the relay opens when threshold crossing is detected and then stays in that position. The power has to be switched off to reset the product.

Undercurrent $<I$, with memory

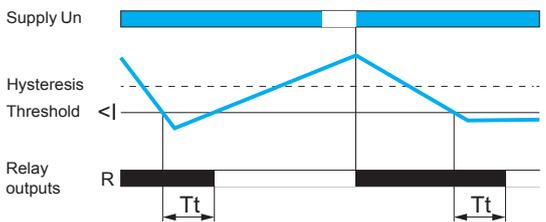

Note: T_t : time delay after crossing of the threshold

RM22JA•1MR/RM35JA32M•

Overcurrent and undercurrent control in window mode

Overcurrent and undercurrent control in window mode $<I<$, without memory

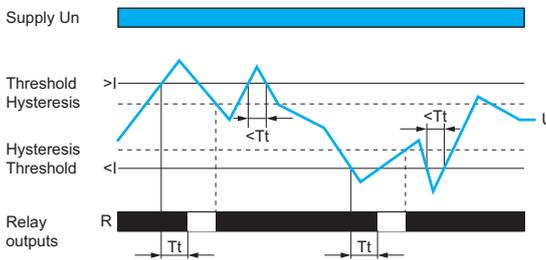

These relays operate in window mode where they check that the controlled current stays between a minimum and a maximum threshold.

■ The undercurrent or overcurrent threshold values are set by means of two graduated potentiometers clearly indicating the I to be monitored. The hysteresis is fixed at 5% of the threshold setting.

■ If the controlled current exceeds the high threshold setting or falls below the low threshold setting for a time greater than that set on the front panel (0.1...30 s), the output relay opens and the R LED goes off. During the time delay, this LED flashes.

■ As soon as the current falls below the high threshold setting value minus the hysteresis, or rises above the low threshold setting value plus the hysteresis, the relay instantly closes.

■ On energization of the device with a detected measured fault, the relay stays open.

Note: T_t : time delay after crossing of the threshold

Zelio Control - Monitoring & Control Relays

1-phase current control relays
RM22JA and RM35JA



RM22JA21MR



RM22JA31MR



RM35JA32MR



RM35JA32MT

References

Function	Rated supply voltage	Measurement range	Time delay	Output	Reference	Weight
	V					kg/lb
■ Overcurrent without memory	24...240 ~	4 mA...1 A ~	No	2 CO 8 A	RM22JA21MR	0.110/ 0.242
■ Overcurrent with/without memory	24...240 ~	4 mA...1 A ~	Off delay (0.1...30 s)	2 CO 8 A	RM22JA31MR	0.110/ 0.242
■ Undercurrent with/without memory						
■ Overcurrent and undercurrent (window mode) with/without memory	24...240 ~	150 mA...15 A ~	Off delay (0.1...30 s)	2 CO 8 A	RM35JA32MR	0.120/ 0.264
	380...415 ~	150 mA...15 A ~	Off delay (0.1...30 s)	2 CO 8 A	RM35JA32MT	0.120/ 0.264

Zelio Control – Monitoring & Control Relays

1-phase current control relays
RM35JA



RM35JA3-MW

Presentation

Multifunction current control relays RM35JA3-MW monitor both AC and DC currents.

Functions	RM35JA31MW	RM35JA32MW
Overcurrent (with/without memory)		
Undercurrent (with/without memory)		
Range controlled	2 ... 500 mA	0.15...15 A

- Function performed
- Function not performed

These control relays allow:

- Automatic AC or DC recognition
- Measurement ranges from 2 mA to 15 A
- Selection between overcurrent and undercurrent
- Measurement as a true rms value
- Selectable memory function
- Clip-on mounting on a 35 mm rail

They feature:

- A sealable cover to help protect the settings
- A control status indicator LED

Applications

- Excitation control of DC machines
- Control of the load state of motors and generators
- Control of current drawn by a 3-phase motor
- Monitoring of heating or lighting circuits
- Control of pump draining (undercurrent)
- Control of overtorque (crushers)
- Monitoring of electromagnetic brakes or clutches

Description

RM35JA31MW, RM35JA32MW

- 1 Configuration: selection of operating mode $<I / >I$, (with or without memory)
Memory - No Memory
- 2 Current threshold setting potentiometer **I%**
- 3 Hysteresis adjustment potentiometer **Hysteresis**
- 4 Time delay adjustment potentiometer **Tt**
- 5 Starting inhibition time delay adjustment potentiometer **Ti**
- 6 Spring for clip-on mounting on 35 mm / 1.38 in. rail

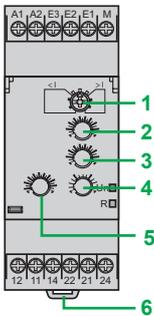

RM35JA31MW, RM35JA32MW

Un Green LED: indicates that supply to the product is on
R Yellow LED: indicates relay output status

Operating principle

Control relays RM35JA3-MW are designed to:

- monitor \sim or $\overline{\sim}$ currents
- automatically recognize the form of $\overline{\sim}$ or \sim (50 or 60 Hz) signal
- directly monitor up to 15 A (above this value a current transformer can be connected)
- signal detected faults by means of LEDs

Function Diagram

- Power supply off
- Power supply on
- Output 11-14, 21-24 open
- Output 11-14, 21-24 closed

Operating principle (continued)

RM35 JA31MW/JA32MW

The operating mode is selected by a switch:

- Undercurrent, with or without memory
- Overcurrent, with or without memory

The position of the switch and the operating mode is read by the product on energization:

- If the switch is set to an unacceptable position, the product detects a fault, the output relay stays open and the LEDs flash to indicate the position error.
- If the switch position is changed while the device is operating, all the LEDs flash, but the product continues to operate normally with the function selected at the time of energization preceding the change of position.
- If the configuration switch is returned to the original position selected prior to the last energization, the LEDs return to their normal state.

The undercurrent or overcurrent threshold value is set by a potentiometer graduated as a percentage of the scale value of current I to be monitored. The hysteresis is adjusted by a potentiometer graduated from 5...50% of the threshold setting and the value must not exceed the limit values of the measuring range.

Overcurrent without memory

- Overcurrent detection $> I$, without memory

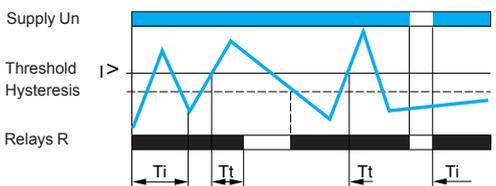

If the current controlled exceeds the threshold setting for a time greater than that set on the front panel (0.3...30 s), the output relay opens and the LED goes off. As soon as the current drops below the value of the threshold setting minus the hysteresis, the relay instantly closes.

Undercurrent without memory

- Undercurrent detection $< I$, without memory

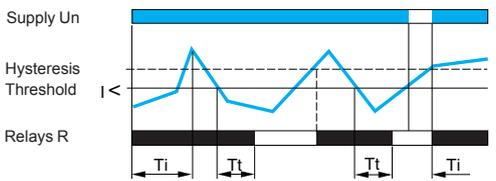

If the current controlled falls below the threshold setting for a time greater than that set on the front panel (0.3...30 s), the output relay opens and the LED goes off. As soon as the current rises above the value of the threshold setting plus the hysteresis, the relay instantly closes.

Overcurrent/Undercurrent with memory

- Overcurrent detection $> I$, with memory

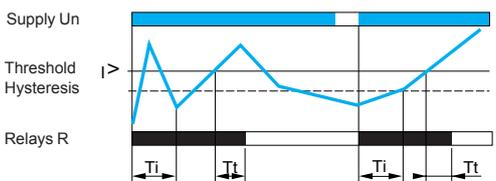

If "Memory" mode is selected, the relay opens when crossing of the threshold is detected and then stays in that position. The power needs to be switched off to reset the product.

On energization, an inhibition time delay (1...20 s) makes it possible to inhibit current peaks (or troughs) on start-up of equipment.

- Undercurrent detection $< I$, with memory



Note: T_i : starting inhibition time (adjustable on front panel)
 T_t : time delay after crossing of the threshold (adjustable on front panel)

References



RM35JA31MW

RM35JA32MW

Function	Range controlled	Supply	Output	Reference	Weight
■ Overcurrent or undercurrent	2...500 mA	24...240 ~	2 CO 5 A	RM35JA31MW	0.130/ 0.286
	0.15...15 A	24...240 ~	2 CO 5 A	RM35JA32MW	0.130/ 0.286

Zelio Control - Monitoring & Control Relays

Liquid level control relays
RM22LA and RM22LG



RM22LG11MR



RM22LA32MT

Presentation

RM22LA and RM22LG liquid level control relays control one or two liquid levels, with a fill or empty function:

Functions	RM22LA 32MR/32MT	RM22LG 11MR/11MT
Level 1/Level 2		
Fill operation		
Empty operation		
Low sensitivity		
Standard sensitivity		
High sensitivity		

■ Function performed
■ Function not performed

RM22 liquid level control relays feature:

- A dial pointer LED indicator for relay power ON status
- A relay output status LED
- A sealable cover to help protect the settings
- A control status indicator LED

The relays are designed for clip-on mounting on a U rail.

Applications

These devices monitor the levels of conductive liquids.

They control the actuation of pumps or valves to regulate levels and can also help prevent submersible pumps "dry running", or tanks "overflowing". They can also be used to control dosing of liquids in mixing processes and to help protect heating elements in the event of non-immersion.

They have a transparent, hinged cover on their front panel to avoid any accidental alteration of the settings. This cover can be directly sealed.

■ Application examples for compatible liquids:

- spring, town, industrial, and sea water
- metallic salt, acid, or base solutions
- liquid fertilizers
- non-concentrated alcohol (< 40%)
- liquids in the food processing industry: beer, coffee, etc.

Description

RM22LG11MR, RM22LG11MT, RM22LA32MR, RM22LA32MT

- 1 Configuration: selection of the operating mode (Fill or Empty) and the sensitivity range (LS/St/HS)
- 2 Sensitivity control potentiometer (k Ω or %)
- 3 Configuration: selection of the number of levels and the On/Off time delay
- 4 Time delay control potentiometer Tt
- 5 Diagnostic button

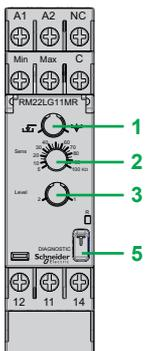

RM22LG11MR

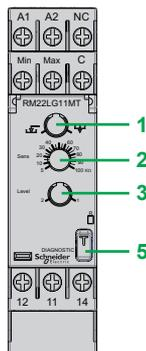

RM22LG11MT

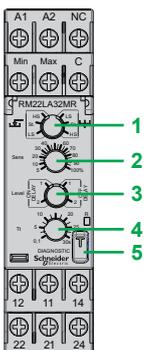

RM22LA32MR

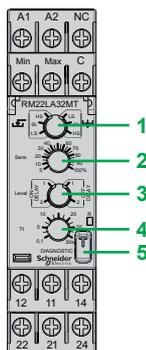

RM22LA32MT

R Yellow LED: indicates relay output status

Zelio Control - Monitoring & Control Relays

Liquid level control relays
RM22LA and RM22LG

Operating principle

Liquid level control relays are designed to measure and control the levels of conductive liquids by means of resistive probes.

The operating principle is based on measurement of the apparent resistance of the liquid between two submerged probes. When this value is less than the threshold setting on the front panel of the device, the relay changes state. To avoid electrolytic phenomena, an AC current runs across the probes.

A selector switch on the front panel allows selection of the required function and the sensitivity range. Control of a single level can be achieved by using the second selector switch. In this case, the Max. level probe stays up in the air and an adjustable time delay avoids any wave effect. Both products activate their output relay when a tank is either emptying or filling.

Function Diagram

	Power supply Off
	Power supply On
	Output 11-14, 21-24 open
	Output 11-14, 21-24 closed

RM22LA and RM22LG

A selector switch on the front panel of these relays allows selection of the required sensitivity range and the empty or fill function. A second switch allows selection of the number of levels (1 or 2) and the type of time delay in the case of level 1 mode. The position of these configuration switches is taken into account on energization.

- If the configuration switch is set to an unacceptable position, the product detects a fault, the output relay stays open, and the LEDs flash to signal the position error.
- If the configuration switch position is changed while the device is operating, all the LEDs flash, but the product continues to operate normally with the function selected at the time of energization preceding the change of position.
- If the configuration switch is returned to the original position selected prior to the last energization, the LEDs return to their normal state.

Control of two levels, empty and fill function

□ Fill/Empty function (2 levels)

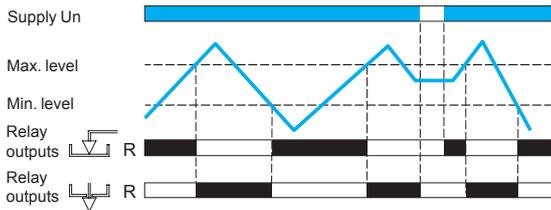

■ Empty function

level: 2, function:

-  **LS** (Low Sensitivity: 250 Ω...5 kΩ)
-  **St** (Standard Sensitivity: 5 kΩ...100 kΩ)
-  **HS** (High Sensitivity: 50 kΩ...1 MΩ)

The output relay stays open until the liquid reaches the Max. level probe.

As soon as the Max. level is reached, the contact closes and then allows emptying of the tank (valve opens, pump starts, etc.). When the level drops below the Min. level, the contact opens to stop the emptying process.

■ Fill function

level: 2, function:

-  **LS** (Low Sensitivity: 250 Ω...5 kΩ)
-  **St** (Standard Sensitivity: 5 kΩ...100 kΩ)
-  **HS** (High Sensitivity: 50 kΩ...1 MΩ)

The output relay stays energized until the liquid reaches the Max. level probe.

As soon as the Max. level is reached, the contact opens and the pump stops.

When the level drops below the Min. level, the contact closes again and pumping restarts to raise the level.

Zelio Control - Monitoring & Control Relays

Liquid level control relays
RM22LA and RM22LG

Operating principle (continued)

RM22LA and RM22LG (continued)

Control of one level, empty function

Empty function T on

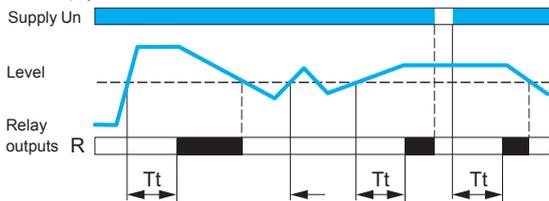

■ Level: 1 - **on delay** functions:

-  **LS** (Low Sensitivity: 250 Ω...5 kΩ)
-  **St** (Standard Sensitivity: 5 kΩ...100 kΩ)
-  **HS** (High Sensitivity: 50 kΩ...1 MΩ)

When the liquid level rises above the probe for a time greater than the time delay value T_t set on the front panel, the relay is energized and stays energized until the liquid level drops back to the probe.

If the liquid drops back below the set level before the end of the time delay, the relay is not energized.

Empty function T off

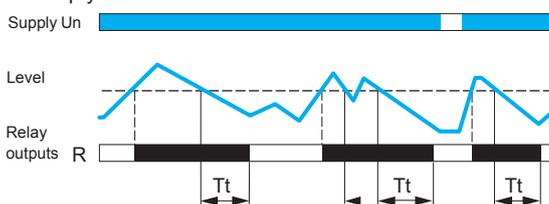

■ Level: 1 - **off delay** functions:

-  **LS** (Low Sensitivity: 250 Ω...5 kΩ)
-  **St** (Standard Sensitivity: 5 kΩ...100 kΩ)
-  **HS** (High Sensitivity: 50 kΩ...1 MΩ)

When the liquid level rises above the probe, the relay is energized instantly and stays energized until the liquid again reaches the probe level for a time T_t set on the front panel.

If the liquid drops back below the set level before the end of the time delay period, the relay stays energized.

Control of one level, fill function

Fill function T on

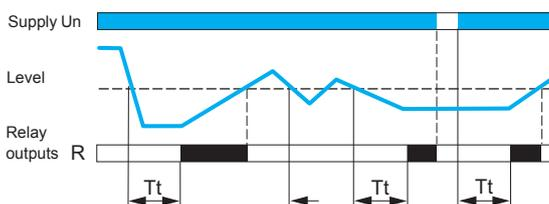

■ Level: 1 - **on delay** functions:

-  **LS** (Low Sensitivity: 250 Ω...5 kΩ)
-  **St** (Standard Sensitivity: 5 kΩ...100 kΩ)
-  **HS** (High Sensitivity: 50 kΩ...1 MΩ)

When the liquid level drops below the probe for a time greater than the time delay value T_t set on the front panel, the relay is energized and stays energized until the liquid level rises back up to the probe.

If the liquid rises back above the set level before the end of the time delay period, the relay is not energized.

Fill function T off

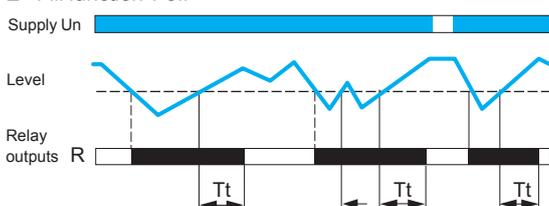

■ Level: 1 - **off delay** functions:

-  **LS** (Low Sensitivity: 250 Ω...5 kΩ)
-  **St** (Standard Sensitivity: 5 kΩ...100 kΩ)
-  **HS** (High Sensitivity: 50 kΩ...1 MΩ)

When the liquid level drops below the probe, the relay is energized instantly and stays energized until the liquid level again reaches the probe level and stays above it for a time greater than the time delay period T_t set on the front panel.

If the liquid drops back below the set level before the end of the time delay period, the relay stays energized.

Note: T_t : time delay after crossing of the threshold

Zelio Control - Monitoring & Control Relays

Liquid level control relays
RM22LA and RM22LG



RM22LG11MR



RM22LG11MT



RM22LA32MR



RM22LA32MT

References

Function	Rated supply voltage	Measurement range	Time delay	Output	Reference	Weight
	V	Ω				kg/lb
<ul style="list-style-type: none"> ■ Level 1/ Level 2 ■ Fill operation ■ Empty operation 	24...240 ~	5 K...100 K	No	1 CO 8 A	RM22LG11MR	0.100/ 0.220
	380...415 ~	5 K...100 K	No	1 CO 8 A	RM22LG11MT	0.100/ 0.220
	24...240 ~	250...1 M	On/Off delay (0.1...30 s)	2 CO 8 A	RM22LA32MR	0.110/ 0.242
	380...415 ~	250...1 M	On/Off delay (0.1...30 s)	2 CO 8 A	RM22LA32MT	0.110/ 0.242

Zelio Control – Monitoring & Control Relays

Level control relays
RM35L



RM35L●●●MW

Presentation

Level control relays RM35LM33MW and RM35LV14MW control 1 or 2 levels, with a fill or empty function:

Functions	RM35LM33MW	RM35LV14MW
Level 1/Level 2		
Fill/Empty operation		
Detection by resistive probes		
Detection by discrete sensors		
Low/Standard/High sensitivity		

- Function performed
- Function not performed

They feature:

- A sealable cover to help protect the settings
- A control status indicator LED

The relays are designed for clip-on mounting on a \lrcorner rail

Applications

These devices monitor the levels of conductive liquid or non-conductive material. They control the actuation of pumps or valves to regulate levels, help protect submersible pumps against dry running, or help protect tanks from “overflow”. They can also be used to control dosing of liquids in mixing processes and help protect heating elements in the event of non-immersion. They have a transparent, hinged cover on their front panel to avoid any accidental alteration of the settings. This cover can be directly sealed.

- Application examples for RM35LM33MW:
 - spring water, town water, industrial water, and sea water
 - metallic salt, acid, or base solutions
 - liquid fertilizers and non-concentrated alcohol (< 40%)
 - liquids in the food processing industry: beer, coffee, etc.
- Application examples for RM35LV14MW:
 - chemically pure water
 - fuels, liquid gases (inflammable)
 - oil, concentrated alcohol (> 40%)
 - ethylene, glycol, paraffin, varnish, and paints

Description

RM35LM33MW

- 1 Configuration: selection of operating mode ∇ / ∇ and of sensitivity range **LS, St, HS**
- 2 Sensitivity adjustment potentiometer %
- 3 Switch for selecting the number of levels
- 4 Time delay adjustment potentiometer **Tt**
- 5 Spring for clip-on mounting on 35 mm/1.38 in. \lrcorner rail

RM35LV14MW

- 2 Configuration: selection of operating mode ∇ / ∇ and of sensor type PNP, NPN
- 3 Time delay adjustment potentiometer **Tt**
- 4 Switch for selecting the number of levels
- 5 Spring for clip-on mounting on 35 mm/1.38 in. \lrcorner rail

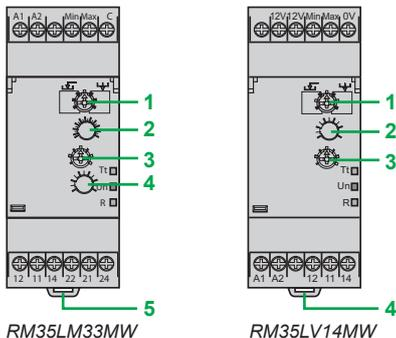

- Tt** Yellow LED: indicates timing status
- Un** Green LED: indicates that supply to the product is on
- R** Yellow LED: indicates relay output status

Operating principle

Control relays RM35LM and RM35LV are designed to control the levels of:

- Conductive liquid for RM35LM (measures the levels by resistive probes)
- Any other material for RM35LV (controls the levels of conductive liquids)

Function Diagram

- Power supply off
- Power supply on
- Output 11-14, 21-24 open
- Output 11-14, 21-24 closed

The operating principle is based on measurement of the apparent resistance of the liquid between two submerged probes. When this value is less than the threshold setting on the front panel of the device, the relay changes state. To avoid electrolytic phenomena, an AC current runs across the probes.

A selector switch on the front panel allows selection of the required function and the sensitivity range. Control of a single level can be achieved by using the second selector switch. In this case, the Max. level probe stays up in the air and an adjustable time delay avoids any wave effect.

Operating principle

RM35LM33MW

Relay RM35LV measures the levels by means of discrete sensors. These two products activate their output relay when a tank is either emptying or filling.

- A green **Un** LED indicates that the supply is on.
- A yellow **R** LED indicates the state of the output relay.
- A yellow **Tt** LED indicates that timing is in progress.
- The green and yellow LEDs flash to indicate an unacceptable setting position.

A selector switch on the front panel of these relays allows selection of the required sensitivity range and the empty or fill function. A second switch allows selection of the number of levels (1 or 2) and the type of time delay in the case of level 1 mode.

The position of these configuration switches is taken into account on energization.

- If the configuration switch is set to an unacceptable position, the product detects a fault, the output relay stays open, and the LEDs flash to signal the position error.
- If the configuration switch position is changed while the device is operating, all the LEDs flash, but the product continues to operate normally with the function selected at the time of energization preceding the change of position.
- If the configuration switch is returned to the original position selected prior to the last energization, the LEDs return to their normal state.

Control of two levels, empty and fill function

□ Fill/Empty function

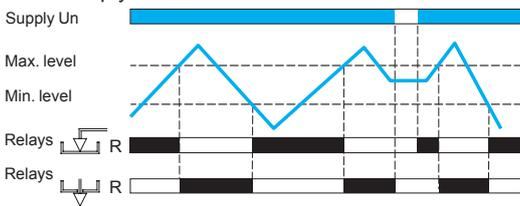

■ Empty function

level: 2, function:

- **LS** (Low Sensitivity: 250 Ω...5 kΩ)
- **St** (Standard Sensitivity: 5 kΩ...100 kΩ)
- **HS** (High Sensitivity: 50 kΩ...1 MΩ)

The output relay stays open until the liquid reaches the Max. level probe. As soon as the Max. level is reached, the contact closes and allows emptying of the tank (valve opens, pump starts, etc.). When the level drops below the Min. level, the contact opens to stop the emptying process.

■ Fill function

level: 2, function:

- **LS** (Low Sensitivity: 250 Ω...5 kΩ)
- **St** (Standard Sensitivity: 5 kΩ...100 kΩ)
- **HS** (High Sensitivity: 50 kΩ...1 MΩ)

The output relay stays energized until the liquid reaches the Max. level probe. As soon as the Max. level is reached, the contact opens and the pump stops. When the level drops below the Min. level, the contact closes again and pumping re-starts to raise the level.

Note: When two levels are being controlled, the anti-wave time delay function is not active.

Control of one level, empty function

□ Empty function T on

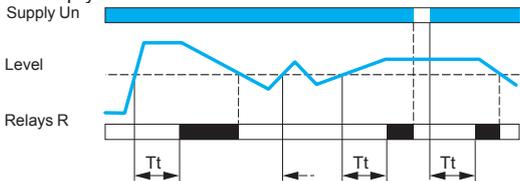

■ Level: 1 - on delay functions:

- **LS** (Low Sensitivity: 250 Ω...5 kΩ)
- **St** (Standard Sensitivity: 5 kΩ...100 kΩ)
- **HS** (High Sensitivity: 50 kΩ...1 MΩ)

When the liquid level rises above the probe for a time greater than the time delay value T_t set on the front panel, the relay is energized and stays energized until the liquid level drops back to the probe.

If the liquid drops back below the set level before the end of the time delay, the relay is not energized.

□ Empty function T off

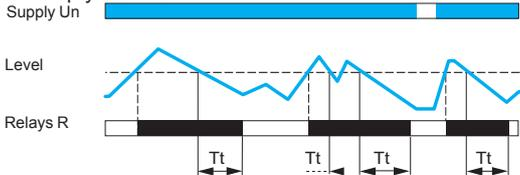

■ Level: 1 - off delay functions:

- **LS** (Low Sensitivity: 250 Ω...5 kΩ)
- **St** (Standard Sensitivity: 5 kΩ...100 kΩ)
- **HS** (High Sensitivity: 50 kΩ...1 MΩ)

When the liquid level rises above the probe, the relay is energized instantly and stays energized until the liquid again reaches the probe level for a time T_t set on the front panel.

If the liquid drops back below the set level before the end of the time delay period, the relay stays energized.

Operating principle (continued)

RM35LM33MW (continued)

Control of one level, fill function

Fill function T on

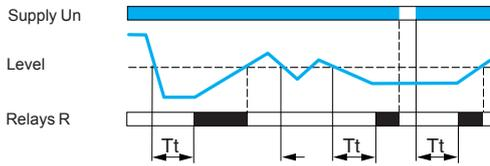

■ Level: 1 - on delay functions:

- **LS** (Low Sensitivity: 250 Ω...5 kΩ)
- **St** (Standard Sensitivity: 5 kΩ...100 kΩ)
- **HS** (High Sensitivity: 50 kΩ...1 MΩ)

When the liquid level drops below the probe for a time greater than the time delay value T_t set on the front panel, the relay is energized and stays energized until the liquid level rises back up to the probe. If the liquid rises back above the set level before the end of the time delay period, the relay is not energized.

Fill function T off

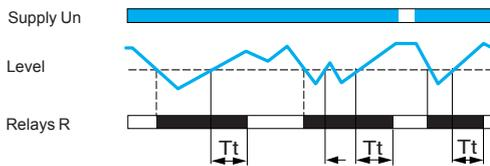

■ Level: 1 - off delay functions:

- **LS** (Low Sensitivity: 250 Ω...5 kΩ)
- **St** (Standard Sensitivity: 5 kΩ...100 kΩ)
- **HS** (High Sensitivity: 50 kΩ...1 MΩ)

When the liquid level drops below the probe, the relay is energized instantly and stays energized until the liquid level again reaches the probe level and stays above it for a time greater than the time delay period T_t set on the front panel. If the liquid drops back down to below the set level before the end of the time delay period, the relay stays energized.

RM35LV14MW

A selector switch on the front panel allows selection of the function (empty or fill) and the type of sensor. A second switch allows selection of the number of levels (1 or 2) and the type of time delay in the case of 1 level mode.

The position of these configuration switches is taken into account on energization.

- If the configuration switch is set to an unacceptable position, the product detects a fault, the output relay stays open, and the LEDs flash to signal the position error.
- If the configuration switch position is changed while the device is operating, all the LEDs flash, but the product continues to operate normally with the function selected at the time of energization preceding the change of position.
- If the configuration switch is returned to the original position selected prior to the last energization, the LEDs return to their normal state.

Control of two levels

Fill/Empty function

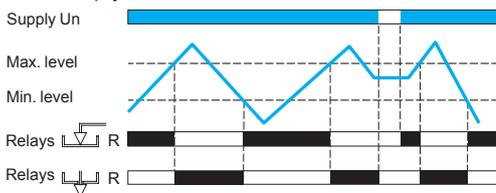

■ Empty function

Level: 2

The output relay stays open until the material reaches the Max. probe level. As soon as the Max. level is reached, the contact closes and allows emptying of the tank (valve opens, pump starts, etc.). When the level drops below the Min. probe level, the contact opens to stop the emptying process.

■ Fill function

Level: 2

The output relay stays energized until the material reaches the Max. probe. As soon as the Max. level is reached, the contact opens and the pump stops. When the level drops below the Min. probe level, the contact closes again and pumping re-starts to raise the level.

Note: When two levels are being controlled, the anti-wave time delay function is not active.

Control of one level, empty function

Empty function T on

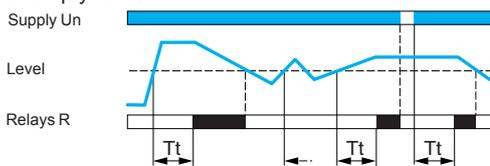

■ Level: 1 - on delay

When the material level rises above the probe for a time greater than the time delay value T_t set on the front panel, the relay is energized and stays energized until the material level drops back to the probe. If the level rises above the probe before the end of time delay period, the relay is not energized.

Empty function T off

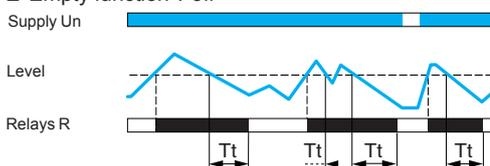

■ Level: 1 - off delay

When the material level rises above the probe, the relay is energized instantly and stays energized until the material level again reaches the probe and stays below it for a time greater than the time delay value T_t set on the front panel. If the level drops back to below the probe before the end of time delay period, the relay stays energized.

Operating principle (continued)

RM35LV14MW (continued)

Control of one level, fill function

□ Fill function T on

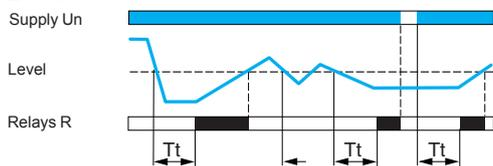

■ Level: 1 - on delay

When the material level drops below the probe for a time greater than the time delay value T_t set on the front panel, the relay is energized and stays energized until the material level again reaches the probe.

If the level rises above the probe before the end of time delay period, the relay is not energized.

□ Fill function T off

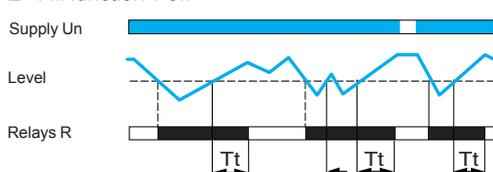

■ Level: 1 - off delay

When the material level drops below the probe, the relay is energized instantly and stays energized until the material level again reaches the probe and stays above it for a time greater than the time delay period T_t set on the front panel.

If the level drops back down to below the probe before the end of the time delay period, the relay stays energized.

References



Function	Supply voltage	Output	Reference	Weight
	V			kg/lb
Detection by resistive probes (see page 68)	24...240 ~	2 CO 5 A	RM35LM33MW	0.130/ 0.287
Detection by discrete sensors	24...240 ~	1 CO 5 A	RM35LV14MW	0.130/ 0.287

Zelio Control - Monitoring & Control Relays

3-phase and 1-phase pump control relays
RM35BA



RM35BA10

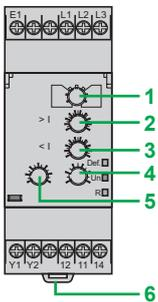

RM35BA

- Def.** Yellow LED: indicates fault present status
- Un** Green LED: indicates that supply to the product is on
- R** Yellow LED: indicates relay output status

Presentation

Measurement and control relay RM35BA10 is used for control and monitoring of 3-phase and single-phase pumps.

Functions	RM35BA10
3-phase phase sequence	
3-phase phase loss	
3-phase overcurrent and undercurrent control	
1-phase overcurrent and undercurrent control	

- Function performed
- Function not performed

These control relays allow:

- Absence of one or more phases
- Undercurrent for protection against dry running
- Overcurrent for protection against overload
- Acceptance of different nominal voltage values:
 - 208...480 V ~ in 3-phase mode
 - 230 V ~ in 1-phase mode
- Clip-on mounting on a \lrcorner rail
- Monitoring of their own supply voltage measured as a true rms value

They feature:

- A sealable cover to help protect the settings
- A control status indicator LED

Applications

- Management of pumps

Description

RM35BA

- 1 Configuration: selection of active function and operating mode **3-ph/1-ph** (Double - Single)
- 2 Overcurrent setting potentiometer $> I$
- 3 Undercurrent setting potentiometer $< I$
- 4 Time delay adjustment potentiometer Tt
- 5 Starting inhibition time delay adjustment potentiometer Ti
- 6 Spring for clip-on mounting on 35 mm/1.38 in. \lrcorner rail

Operating principle

Pump control relay RM35BA10 can operate on a 1-phase or 3-phase supply and incorporates 3 functions in a single unit:

- Current control
- Phase presence control (in 3-phase mode)
- Phase sequence control (in 3-phase mode)

Function Diagram

- Power supply off
- Power supply on
- Output 11-14, 21-24 open
- Output 11-14, 21-24 closed

These relays have two operating modes which are designed to control a pump via two external signal inputs (Y1 and Y2). These two signal inputs are controlled by volt-free contacts.

Control signal inputs Y1 and Y2 can be connected to:

- A level sensor
- A level relay
- A pressure sensor
- A pushbutton, etc.

Fault signaling is by LEDs with differentiation of the reason for the fault.

RM35BA10

The following operating mode is selected by using a switch:

- Single control
- Double control
- 1-phase or 3-phase supply

The position of the switch and the operating mode is read by the product on energization.

- If the switch position is changed while the device is operating, all the LEDs flash, but the product continues to operate normally with the function selected at the time of energization preceding the change of position.
- If the configuration switch is returned to the original position selected prior to the last energization, the LEDs return to their normal state.

Operating principle (continued)

RM35BA10 (continued)

Single control mode

- Single control mode (3-ph/1-ph)

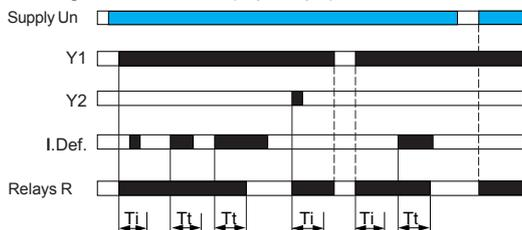

This mode is designed to control a pump via an external signal. The relay output is closed when the signal is present at Y1 (contact closed). Y2 can be used to reset the relay after a current fault.

Note: *Ti*: time delay to inhibit fault monitoring on pump starting (overcurrent and undercurrent, setting on front panel)
Tt: time delay on occurrence of a fault (overcurrent or undercurrent, setting on front panel)
I. Def.: presence of a current fault (overcurrent or undercurrent)

Double control mode

- Double control mode (3-ph/1-ph)

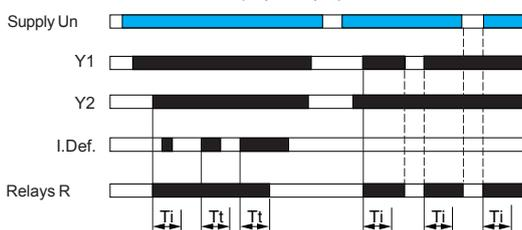

This mode is designed to control a pump via two external control signals (Y1 and Y2). The output relay closes when both input signals are present (Y1 and Y2 closed). It will open as soon as one of these signals disappears.

Note: *Ti*: time delay to inhibit fault monitoring on pump starting (overcurrent and undercurrent, setting on front panel)
Tt: time delay on occurrence of a fault (overcurrent or undercurrent, setting on front panel)
I. Def.: presence of a current fault (overcurrent or undercurrent)

1-phase or 3-phase supply control mode

- Overcurrent detection $I >$



- If the control relay is configured for a 1-phase supply, it monitors the current consumed by the pump.
- If the control relay is configured for a 3-phase supply, it monitors the current, phase sequence and phase loss.
- If a phase fault is detected, the output relay opens immediately.
- On energization, if there is a phase sequence or phase loss fault, the output is unable to energize.

The overcurrent and undercurrent values are set by two separate potentiometers, graduated from 1 to 10 A.

- If a setting error occurs (low threshold greater than high threshold), the output relay opens and all the LEDs flash to signal the error.
- If a current fault occurs (overcurrent or undercurrent), the relay opens when the fault persists for longer than the threshold time delay setting.
- When the current returns to the correct value, the output relay continues to remain open. It can only be re-energized by a RESET: either by switching off the power, or by closing external contact Y2 (in single control mode).
- An inhibition time delay on energization (*Ti*) allows detection of current peaks on motor starting.

Note: *Ti*: time delay to inhibit fault monitoring on pump starting (overcurrent and undercurrent, setting on front panel)
Tt: time delay on occurrence of a fault (overcurrent or undercurrent, setting on front panel)

- Undercurrent detection $I <$

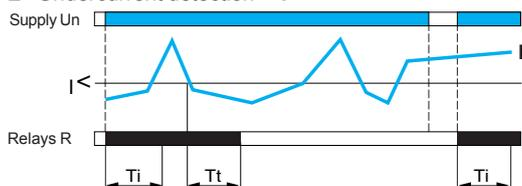

References



RM35BA10

Function	Current range controlled	Supply voltage	Output Reference	Weight
	A	V		
3-phase:	1...10	■ 208...480 ~, 3-phase	1 CO 5 A RM35BA10	0.110/ 0.243
<ul style="list-style-type: none"> ■ Phase sequence ■ Phase loss ■ Overcurrent and undercurrent control 		■ 230 ~, 1-phase		
1-phase:				
<ul style="list-style-type: none"> ■ Overcurrent and undercurrent control 				



RM35HZ21FM

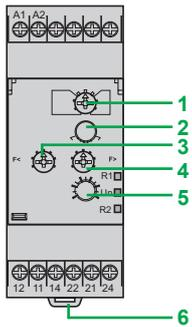

RM35HZ21FM

R1 Yellow LED: indicates relay status (high frequency threshold)

Un Green LED: indicates that supply to the product is on

R2 Yellow LED: indicates relay status (low frequency threshold)

Presentation

Frequency control relay RM35HZ monitors frequency variations on 50 or 60 Hz AC supplies:

Functions	RM35HZ21FM
Over-frequency (50 or 60 Hz)	
Under-frequency (50 or 60 Hz)	

- Function performed
- Function not performed

These control relays allow:

- Over-frequency and under-frequency with two independent relay outputs
- Selectable memory function
- Monitoring of their own supply voltage measured as a true rms value
- Clip-on mounting on a 35 mm / 1.38 in. rail

They feature:

- A sealable cover to help protect the settings
- A control status indicator LED

Applications

Monitoring of electrical power sources:

- Generating sets, wind turbines, micro-power stations, etc.

Description

RM35HZ21FM

- 1 Configuration: selection of 50/60 Hz frequency range and operating mode (with or without memory) **Memory - No Memory**
- 2 Frequency tolerance multiplication setting potentiometer **x1-x2**
- 3 Low frequency threshold setting switch **F <**
- 4 High frequency threshold setting switch **F >**
- 5 Time delay adjustment potentiometer
- 6 Spring for clip-on mounting on 35 mm / 1.38 in. rail

Operating principle

Frequency control relay RM35HZ monitors:

- Frequency variations on 50 or 60 Hz supplies
- Over-frequency and under-frequency via adjustment of two independent thresholds. (It has two relay outputs: one per threshold)
- Fault signaling is by LED

Function Diagram

	Power supply off
	Power supply on
	Output 11-14, 21-24 open
	Output 11-14, 21-24 closed

- Function selector switch:
 - Set the switch to a frequency of 50 or 60 Hz of the supply monitored, then select Memory or No memory mode.
 - The position of the switch and the operating mode is read by the product on energization.
 - If the switch is set to an unacceptable position, the product detects a fault, the output relays stay open and the LEDs flash to indicate the position error.
 - If the switch position is changed while the device is operating, all the LEDs flash but the product continues to operate normally with the function selected at the time of energization preceding the change of position.
 - If the switch is returned to the original position selected prior to the last energization, the LEDs return to their normal state.

Operating principle (continued)

RM35HZ21FM

The under-frequency or over-frequency threshold values are set using two graduated potentiometers indicating the variation value of the frequency to be monitored. A switch **x1/x2** allows the control scale to be doubled. Hysteresis is fixed at 0.3 Hz.

Over-frequency and under-frequency without memory

- Over-frequency and under-frequency control, without memory

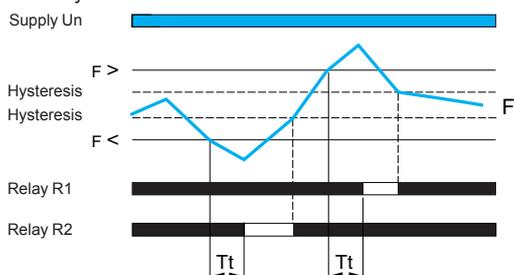

- If the frequency of the voltage controlled exceeds the over-frequency threshold setting for a time greater than that set on the front panel (0.1...10 s), the corresponding output relay opens and its LED goes off. During the time delay, this LED flashes.
- As soon as the frequency drops below the value of the threshold setting, minus the hysteresis, the relay instantly closes.
- If the frequency of the voltage controlled falls below the under-frequency threshold setting for a time greater than that set on the front panel (0.1...10 s), the corresponding output relay opens and its LED goes out. During the time delay, this LED flashes.
- As soon as the frequency rises above the value of the threshold setting, plus the hysteresis, the relay instantly closes.
- On energization of the device with a detected measured fault, the relay stays open.

Note: T_t : time delay after crossing of the threshold (adjustable on front panel)

Over-frequency and under-frequency with memory

- Over-frequency and under-frequency control with memory

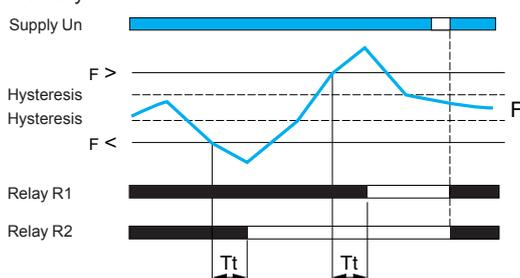

If "Memory" mode is selected, the relay opens after the time delay and stays in that position when crossing of the threshold is detected. The power needs to be switched off to reset the product.

Note: T_t : time delay after crossing of the threshold (adjustable on front panel)

Reference



RM35HZ21FM

Function	Range controlled	Supply voltage	Output	Reference	Weight
		V			kg/lb
■ Over-frequency and under-frequency 50 or 60 Hz	40...60 Hz (50 Hz) / 50...70 Hz (60 Hz)	120...277 ~	1 CO + 1 CO 5 A	RM35HZ21FM	0.130/ 0.287



RM35S0MW

Presentation

Speed control relay RM35S0MW monitors:

Functions	RM35S0MW
Underspeed (with/without memory, with inhibition by external contact S2)	
Overspeed (with/without memory, with inhibition by external contact S2)	

- Function performed
- Function not performed

Speed control relay RM35S0MW measures via:

- A 3-wire PNP or NPN proximity sensor input
- A Namur proximity sensor input
- A 0-30 V voltage input
- A volt-free contact input

These control relays allow:

- Operation with either NO or NC sensors
- Adjustable time between impulses from 0.05 s... 10 min
- Adjustable power-on inhibition time from 0.6 to 60 s
- Inhibition controlled by an external contact
- Clip-on mounting on a 35 mm / 1.38 in. rail

They feature:

- A sealable cover to help protect the settings
- A control status indicator LED

Applications

Monitoring the speed or rate of rotary or linear movements in the following applications:

- conveyors/conveyor belts
- packaging
- material handling

Description

RM35S00MW

- 1 Configuration: selection of operating mode: Underspeed or overspeed
Underspeed/Overspeed
with or without memory **Memory - No Memory**
- 2 Speed threshold setting potentiometer **Value**
- 3 Speed range selector switch
- 4 Starting inhibition time delay adjustment potentiometer **Ti**
- 5 Spring for clip-on mounting on 35 mm / 1.38 in. rail

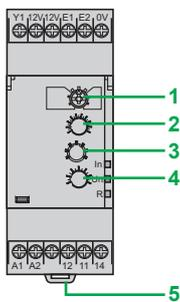

RM35S0MW

In Yellow LED: indicates inhibition status (time delay or S2 input)

Un Green LED: indicates that supply to the product is on

R Yellow LED: indicates relay output status

Operating principle

Relay RM35S0MW monitors the speed (rate, frequency) of a process (conveyor, conveyor belt, etc.) using discrete sensors:

- 3-wire PNP or NPN proximity sensor
- 0-30 V voltage input
- NAMUR proximity sensor
- volt-free contact

It can be used for monitoring underspeed or overspeed.

Function Diagram

-  Power supply off
-  Power supply on
-  Output 11-14, 21-24 open
-  Output 11-14, 21-24 closed

RM35S0MW

The control relay measures the speed as follows:

- The cycle of the process being monitored is a series of impulses characterized by a two-state signal: high and low.
- The speed is obtained by measuring the period of this signal, from the detection of first change of state (either rising or falling edge).
- Digital processing of the signal allows the disparity between the signals to be calculated.
- On energization or after appearance (or reappearance) of the sensor signal, detection (characterization) of the signal requires processing of one or two periods. During this time, control is inoperative.

The operating modes are selected by using the switch:

- Underspeed without memory
- Underspeed with memory
- Overspeed without memory
- Overspeed with memory

Underspeed control without memory

- Underspeed control, without memory

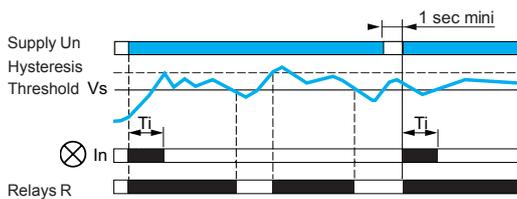

At the end of the starting inhibition time delay “Ti”, as soon as the speed measured drops below the threshold setting, the output relay changes state from “closed” to “open”.

It returns to its initial state when the speed is again higher than the threshold plus hysteresis (fixed at 5% of the threshold setting).

When power is restored, after a break having lasted at least 1 s, the relay is in the “closed” state during the time delay and stays in that state for as long as the speed remains higher than the threshold.

Underspeed control with memory

- Underspeed control, with memory

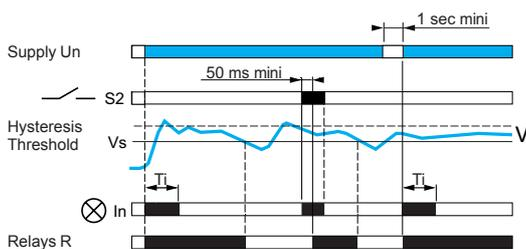

When relay RM35S has been configured in “memory” mode, if underspeed is detected, the output relay stays in the “open” state, irrespective of any further changes in the process speed.

It will not be able to return to the “closed” state until contact S2 closes (for at least 50 ms).

If, when S2 re-opens, the speed is not high enough, the relay returns to “open” state. Relay RM35S can also be reset by a power break (at least 1 s); the relay then returns to the “closed” state for at least the duration of the time delay, irrespective of the process speed.

Operating principle (continued)

RM35S0MW

Underspeed control with inhibition by S2

- With inhibition by S2 **Inhib./S2**

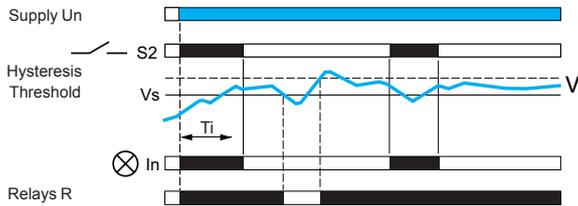

On energization, to allow the process being monitored to reach its nominal operating speed, relay RM35S is inhibited for a time delay adjustable from 0.6...60 s. This time delay can be adjusted (shortened or lengthened) during inhibition.

Relay RM35S can also be inhibited by closing of contact S2: on starting, for example, if the process run-up to speed time is greater than 60 s, or at any time during operation.

Whether it results from a starting inhibition time delay or closing of S2, inhibition keeps the output relay in the “closed” position and is signaled by illumination of the inhibition LED.

If, after lifting of inhibition (end of starting inhibition time delay or opening of contact S2), the signal detection phase has not been completed, the relay drops out after the set wait time between two impulses (measured from the end of inhibition).

Inhibition should last as long as is necessary for the product to detect at least 2 periods.

When the signal has not been ‘characterized’ by the end of the inhibition period, the “inhibition” LED flashes for as long as speed measurement is impossible.

It is also possible to inhibit relay RM35S at any time, during operation, by closing S2.

Overspeed control without memory

- Overspeed control, without memory

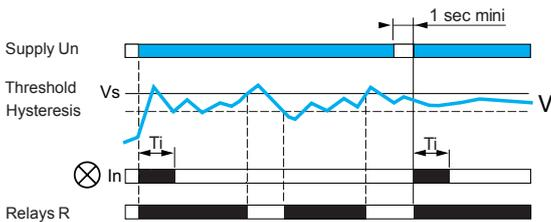

At the end of the starting inhibition time delay, “Ti”, as soon as the speed measured is higher than the threshold setting, the output relay changes state from “closed” to “open”.

It returns to its initial state when the speed is again lower than the threshold minus hysteresis (fixed at 5% of the threshold setting).

When power is restored to relay RM35S, after a break having lasted at least 1 s, the relay is in the “closed” state during the time delay and stays in that state for as long as the speed remains lower than the threshold.

Overspeed control with memory

- Overspeed control, with memory

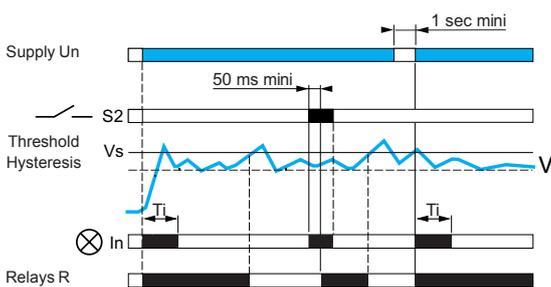

When relay RM35S has been configured in “memory” mode, if overspeed is detected, the output relay stays in the “open” state, irrespective of any further changes in the process speed.

It will not be able to return to the “closed” state until contact S2 closes (for at least 50 ms).

If, when S2 re-opens, the speed is too high, the relay returns to the “open” state.

Relay RM35S can also be reset by a power break (at least 1 s); the relay then returns to the “closed” state for at least the duration of the time delay, irrespective of the process speed.

Operating principle (continued)

RM35S0MW

Overspeed control with inhibition by S2

□ With inhibition by S2. **Inhib./S2**

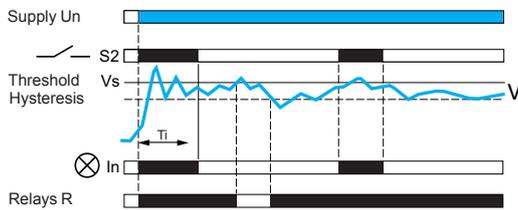

On energization, in order to allow the process being monitored to reach its nominal operating speed, relay RM35S is inhibited for a time delay adjustable from 0.6...60 s. This time delay can be modified (shortened or lengthened) during inhibition.

Relay RM35S can also be inhibited by closing of contact S2: on starting, for example, if the process run-up to speed time is greater than 60 s, or at any time during operation.

Whether it results from a starting inhibition time delay or closing of S2, inhibition keeps the output relay in the “closed” position and is signaled by illumination of the inhibition LED.

If, after lifting of inhibition (end of starting inhibition time delay or opening of contact S2), the signal detection phase has not been completed, the relay drops out after the set wait time between two impulses (measured from the end of inhibition).

Inhibition should last as long as is necessary for the product to detect at least 2 periods. When the signal has not been ‘characterized’ by the end of the inhibition period, the “inhibition” LED flashes for as long as speed measurement is impossible.

It is also possible to inhibit relay RM35S at any time, during operation, by closing S2.

Reference



RM35S0MW

Function	Supply voltage V	Measurement Input	Output	Reference	Weight kg/lb
<ul style="list-style-type: none"> ■ Underspeed ■ Overspeed 	24...240 ~	<ul style="list-style-type: none"> ■ 3-wire PNP or NPN proximity sensor ■ Namur proximity sensor ■ 0-30 V voltage ■ Volt-free contact 	1 CO 5 A	RM35S0MW	0.130/ 0.287

Zelio Control - Monitoring & Control Relays

Temperature control relays for elevator machine rooms and 3-phase supplies

RM35ATL, RM35ATR, and RM35ATW



RM35AT0MW

Presentation

Measurement and control relays RM35ATL0MW, RM35ATR5MW and RM35ATW5MW are designed for monitoring the temperature in elevator machine rooms, in compliance with directive EN81.

Functions	RM35ATL0MW	RM35ATR5MW	RM35ATW5MW
Overtemperature (34...46 °C)			
Undertemperature (-1...11 °C)			
Phase sequence			
Phase loss			

- Function performed
- Function not performed

These control relays allow:

- PT100 input
- Adjustable control around 5 °C and 40 °C
- Independent adjustment of high and low thresholds
- Possibility of integrated phase control
- Clip-on mounting on a U rail

They feature:

- A sealable cover to help protect the settings
- A control status indicator LED

Applications

- Temperature control for elevator machine rooms

Description

RM35ATL0MW, RM35ATR5MW

- 1 High temperature threshold setting potentiometer $\theta>$
- 2 Potentiometer for adjustment of time delay on crossing of temperature threshold Tt
- 3 Low temperature threshold setting potentiometer $\theta<$
- 4 Spring for clip-on mounting on 35 mm/1.38 in. U rail
- 5 High temperature threshold contact (11-14)
- 6 Low temperature threshold contact (21-24)
- 7 High and low temperature threshold contacts

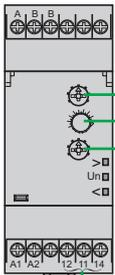

RM35ATL0MW

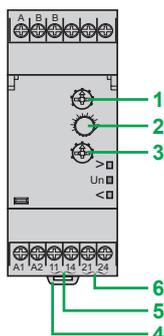

RM35ATR5MW

- > Yellow LED: indicates relay output status (high temperature threshold)
- Un Green LED: indicates that supply to the product is on
- < Yellow LED: indicates relay output status (low temperature threshold)

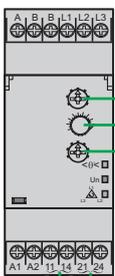

RM35ATW5MW

- < $\theta<$ > Yellow LED: indicates temperature relay output status **R1**
- Un Green LED: indicates that supply to the product is on
- L_1 L_2 Yellow LED: indicates phase relay output status **R2**

RM35ATW5MW

- 1 High temperature threshold setting potentiometer $\theta>$
- 2 Potentiometer for adjustment of time delay on crossing of temperature threshold Tt
- 3 Low temperature threshold setting potentiometer $\theta<$
- 4 Spring for clip-on mounting on 35 mm/1.38 in. U rail
- 5 Temperature relay contact (11-14)
- 6 Phase relay contact (21-44)

Operating principle

Temperature control relays for elevator machine rooms are designed to monitor the stated temperature between 5 °C and 40 °C in compliance with directive EN81.

Function Diagram

- Power supply off
- Power supply on
- Output 11-14, 21-24 open
- Output 11-14, 21-24 closed

Zelio Control - Monitoring & Control Relays

Temperature control relays for elevator machine rooms and 3-phase supplies
RM35ATL, RM35ATR, and RM35ATW

Operating principle (continued)

RM35ATL0MW

Temperature control by PT100 probe

- Temperature control by PT100 probe

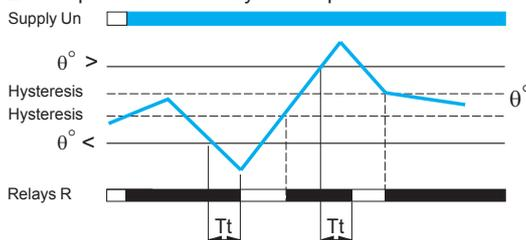

After a delay on pick-up after energization, and for as long as the temperature monitored by the PT100 probe remains between the two thresholds set on the front panel, the output relay is closed and the yellow LEDs are on.

When the temperature crosses one of the threshold settings on the front panel (high or low threshold), the time delay set on the front panel (T_t) is activated. The yellow LED corresponding to the threshold crossed (low or high) flashes.

At the end of the time delay, if the temperature is still outside the threshold setting, the output relay opens and the yellow LED corresponding to the threshold crossed goes out. The output relay closes instantly (within the response time on disappearance of a fault) when the temperature returns within the window of the two threshold settings on the front panel, plus the fixed hysteresis.

If the PT100 probe is incorrectly wired (missing or short-circuited) the relay is open and the 3 LEDs flash.

Note: T_t : time delay after crossing of the temperature threshold (adjustable on front panel)

RM35ATR5MW

Temperature control by PT100 probe

- Temperature control by PT100 probe

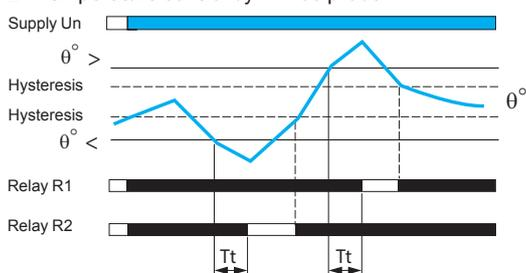

After a delay on pick-up after energization, and for as long as the temperature monitored by the PT100 probe remains between the two threshold settings on the front panel, the output relays are closed and their yellow LEDs are on.

When the temperature crosses one of the threshold settings on the front panel (high or low threshold), the time delay set on the front panel (T_t) is activated. The yellow LED corresponding to the threshold crossed (low or high), flashes.

At the end of the time delay, if the temperature is still outside one of the threshold settings, the corresponding output relay opens and the yellow LED corresponding to the threshold crossed goes out.

The output relay closes instantly (response time on disappearance of a fault) when the temperature returns within the window of the two threshold settings on the front panel, plus (or minus) the fixed hysteresis.

If the PT100 probe is incorrectly wired (missing or short-circuited) the relays are open and the 3 LEDs flash.

Note: T_t : time delay after crossing of the temperature threshold (adjustable on front panel)

RM35ATW5MW

Temperature and phase control

- Temperature control by PT100 probe
- Sequence of phases L1, L2, and L3
- Phase loss

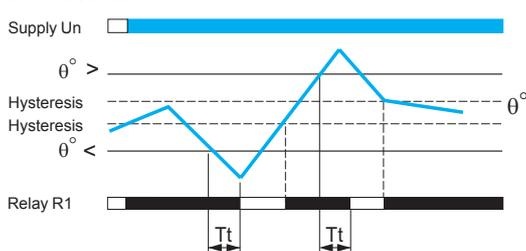

After a delay on pick-up after energization, and for as long as the temperature monitored by the PT100 probe remains between the two threshold settings on the front panel, the temperature relay R1 is closed.

When the temperature crosses one of the threshold settings on the front panel (high or low threshold), the time delay set on the front panel (T_t) is activated. The yellow temperature LED flashes. At the end of the time delay, if the temperature is still outside the threshold setting, the output relay R1 opens and the yellow LED goes out.

The output relay R1 closes instantly when the temperature returns to within the window of the two threshold settings on the front panel, plus or minus the fixed hysteresis. The device also monitors the correct sequence of phases L1, L2, and L3 of the 3-phase supply and total phase loss, even in the case of phase regeneration (< 70%).

After a delay on pick-up after energization, and for as long as phase presence and phase sequence are correct, relay R2 and the "phase" LED are On. When a fault appears, the "phase" relay opens and the "phase" LED instantly goes out (response time on appearance of a fault).

When the fault disappears, the phase control relay and LED are activated (response time on disappearance of a fault).

If the PT100 probe is incorrectly wired (missing or short-circuited) relay R1 is open and LED R1 flashes.

Note: T_t : time delay after crossing of the temperature threshold (adjustable on front panel)

References



RM35ATL0MW



RM35ATR5MW

Function	Supply voltage	3-phase control	Output	Reference	Weight
	V	V			kg/lb
■ Overtemperature: 34...46 °C	24...240	—	1 CO	RM35ATL0MW	0.130/ 0.287
■ Undertemperature - 1...11 °C	~		5 A		
		—	2 NO	RM35ATR5MW	0.130/ 0.287
			5 A		
■ Overtemperature: 34...46 °C	24...240	208...480	2 NO	RM35ATW5MW	0.130/ 0.287
■ Undertemperature - 1...11 °C	~	~	5 A		
■ Phase sequence					
■ Phase loss					

Zelio Control - Monitoring & Control Relays

Electrode holders and probes

Probes						
Application	No. of probes	Length	Operating temperature	Maximum pressure	Reference	Weight
		mm/in.	°C/°F	kg/cm ²		kg/lb
Recommended for drinks vending machines and where installation space is limited (Stainless steel)	3	1000/39.37	80/176	2	RM79696044	0.800/1.764

Suitable for boilers, pressure vessels and high temperature conditions (1) (304 stainless steel)	1	1000/39.37	200/392	25	RM79696014	0.360/0.794
--	---	------------	---------	----	------------	-------------

Description	Material	Reference	Weight
			kg/lb
Protected probe for mounting by suspension	Protective shell PUC (S7) Electrode: stainless steel	RM79696043	0.150/0.331

Description	Type of installation	Maximum operating temperature	Reference	Weight
		°C/°F		kg/lb
Liquid level control probe	Suspended by cable	100/212	LA9RM201	0.100/0.220



RM79696043



LA9RM201

(1) 3/8" BSP mounting thread with hexagonal head. Use a 24 mm (0.95 in.) spanner for tightening.

Zelio Control - Monitoring & Control Relays

Electrode holders and probes



RM79696006

Electrode holders

Description	Material	Reference	Weight kg/lb
Electrode for use up to 350 °C and 15 kg/cm ² (1)	Ceramic-insulated stainless steel	RM79696006	0.150/ 0.331

(1) 3/8" BSP mounting thread.

L

LA9RM201 68

R

RM17JC00MW	43
RM17TA00	21
RM17TE00	21
RM17TG00	13
RM17TG20	13
RM17TT00	21
RM17TU00	21
RM17UAS14	35
RM17UAS15	35
RM17UAS16	35
RM17UB310	27
RM17UBE15	35
RM17UBE16	35
RM22JA21MR	47
RM22JA31MR	47
RM22LA32MR	53
RM22LA32MT	53
RM22LG11MR	53
RM22LG11MT	53
RM22TA31	17
RM22TA33	17
RM22TG20	17
RM22TR31	17
RM22TR33	17
RM22TU21	17
RM22TU23	17
RM22UA21MR	41
RM22UA22MR	41
RM22UA23MR	41
RM22UA31MR	41
RM22UA32MR	41
RM22UA33MR	41
RM22UA33MT	41
RM22UB34	41
RM35ATL0MW	67
RM35ATR5MW	67
RM35ATW5MW	67
RM35BA10	59
RM35HZ21FM	61
RM35JA31MW	49
RM35JA32MR	47
RM35JA32MT	47
RM35JA32MW	49
RM35LM33MW	57
RM35LV14MW	57
RM35S0MW	65
RM35TF30	23
RM35TM50MW	31
RM35TM250MW	31
RM35UA11MW	37
RM35UA12MW	37
RM35UA13MW	37
RM35UB3N30	27
RM35UB330	27
RM79696006	69
RM79696014	68
RM79696043	68
RM79696044	68

Relays



Schneider Electric Industries SAS

Head Office
35, rue Joseph Monier
F-92500 Rueil-Malmaison
France

www.schneider-electric.com/relays

The information provided in this documentation contains general descriptions and/or technical characteristics of the performance of the products contained herein. This documentation is not intended as a substitute for and is not to be used for determining suitability or reliability of these products for specific user applications. It is the duty of any such user or integrator to perform the appropriate and complete risk analysis, evaluation and testing of the products with respect to the relevant specific application or use thereof. Neither Schneider Electric nor any of its affiliates or subsidiaries shall be responsible or liable for misuse of the information contained herein.

Design: Schneider Electric
Photos: Schneider Electric